



**SEI**  
INDUSTRIES



**Bambi**  
**BUCKET®**  
Driven by Innovation

***BAMBI BUCKET***  
(2024-4453 MODELS)  
***SERVICE***  
***MANUAL***

***2013 VERSION E***

---

**BAMBI BUCKET SERVICE MANUAL - Version E  
(Models 2024-4453 only)**

**Issue Date: April 2013**

**PLEASE READ BEFORE USING.**

**SEI INDUSTRIES LTD.**

7400 Wilson Avenue  
Delta, B.C. Canada  
V4G 1E5

Phone: (604) 946-3131

Fax: (604) 940-9566

E-Mail: [seisales@sei-ind.com](mailto:seisales@sei-ind.com)

Website: [www.sei-ind.com](http://www.sei-ind.com)

COPYRIGHT © 2013 SEI INDUSTRIES LTD. ALL RIGHTS RESERVED

PRINTED IN CANADA



**Bambi Bucket Service Manual (Models 2024-4453) (Version E)**

---

# Table of Contents

<b>Section 1: Introduction</b>	<b>1</b>
Bambi Bucket (Models 2024–4453)	1
<b>Section 2: Deploying the Bambi Bucket</b>	<b>2</b>
Deployment Instructions	2
<i>Attaching to the Cargo Hook</i>	2
<i>Control Head Operation</i>	4
<i>Connecting Power</i>	4
<i>Using Longlines</i>	5
Instant Deployment System (IDS)	9
<b>Section 3: Using Accessories</b>	<b>10</b>
Using Foam	10
<i>Sacksafoam Foam Injection System</i>	10
<i>Compatible Bambi Bucket/Sacksafoam Models</i>	11
Using the Firesock	12
<b>Section 4: Making Adjustments</b>	<b>13</b>
Adjusting Various Components	13
<i>Adjusting the Dump Valve Udder</i>	13
<i>Adjusting the Udder via the Tripline</i>	13
<i>Adjusting Purse Strings in the Dump Valve</i>	14
<i>Checking Purse Line Adjustment</i>	15
<b>Section 5: Packing and Storage</b>	<b>16</b>
Packing and Storing	16
<i>Packing the Bucket</i>	16
<i>Storing the Bambi Bucket</i>	19
<b>Section 6: Troubleshooting Guide</b>	<b>20</b>
General Troubleshooting Guide	20
<i>Control Head Troubleshooting</i>	21
<b>Section 7: Control Head Maintenance</b>	<b>25</b>
Operation and Maintenance	25
<i>Control Head Operation</i>	25
Tripline Replacement	25
<i>Removing the Old Tripline</i>	26
<i>Winding the Spring Reel</i>	28
<i>Installing a New Tripline</i>	28
Spring Power Reel Replacement	32
<i>Removing Old Spring Reel</i>	32
<i>Catch Replacement</i>	36

---

## Section 8: General Maintenance and Repairs 38

Maintenance and Repairs .....	38
<i>Purse Line Replacement</i> .....	38
<i>Purse Line Specifications</i> .....	38
<i>Suspension Line Replacement</i> .....	40
<i>M-Strap Replacement</i> .....	41
<i>Removing Old M-Straps</i> .....	42
<i>Installing New M-Straps (Short)</i> .....	42
<i>Installing New M-Straps (Long)</i> .....	45
<i>Dump Valve Replacement</i> .....	47
<i>Bottom Loop Repairs</i> .....	48
<i>Bucket Patching</i> .....	48
<i>IDS Hub/Spokes Replacement</i> .....	49
<i>Load Test on the Hook</i> .....	50
Bambi Bucket Shell Repairs .....	51
<i>Repair Failures</i> .....	51
<i>Repairing in High Humidity</i> .....	52
<i>Making Temporary Repairs with Sealing Clamps</i> .....	53
Temporary Repairs Using Glue .....	55
<i>Applying the Glue</i> .....	55
<i>Gluing with Patches</i> .....	56
<i>Cutting the Patch</i> .....	57
<i>Applying the Patch</i> .....	58
<i>Using Other Glues</i> .....	59
Hot Air Gun Patching .....	60
<i>Hot Air Gun Procedure</i> .....	61
Repair Kits .....	63
<i>Bambi Repair Kit REPKM001</i> .....	63

## Section 9: Specifications and Parts 64

Capacity and Weight Specifications .....	64
<i>Control Head Parts List, Models 2024-4453, Major Components</i> .....	65
<i>Control Head Parts List, Models 2024-4453, Bolts, Nuts and Washers</i> .....	66
<i>Control Head Parts List, Models 2024-4453, Catch, Linkage, Terminal</i> .....	67
<i>Control Head Parts List, Models 2024-4453, Clevis, Cotter and Split Pins</i> ..	68
<i>Valve Models 2024-3542</i> .....	69
<i>Valve Model 4453</i> .....	70
<i>Valve Kits</i> .....	71
<i>Bucket Shell, Models 2024-4453</i> .....	72
<i>Bucket Shell, Models 2024-4453 (continued)</i> .....	73
<i>Cinch Strap, Models 2024-4453</i> .....	74
<i>Rigging, Models 2024-4453</i> .....	76
<i>Rigging, Models 2024-4453 (continued)</i> .....	77
<i>IDS System, Models 2024-4453</i> .....	78
<i>IDS System, Models 2024-4453 (continued)</i> .....	79
<i>Ballast Systems, Models 2024-3542</i> .....	81
<i>Ballast Systems, Model 4453</i> .....	82
<i>Packaging Parts List</i> .....	83

---

Section 10: Warranty	84
Section 11: Drawings	85
<i>Pilot Controls</i> .....	85
<i>Pilot Controls, US InterAgency</i> .....	86
<i>Bambi Crew Controls</i> .....	87
<i>Bambi Crew Controls (using remote power supply)</i> .....	88

## Section 1: Introduction

### Bambi Bucket (Models 2024–4453)

This manual provides helicopter operators with information on the service and maintenance of the Bambi bucket. This service manual also includes all parts lists and installation drawings. A separate Bambi bucket operations manual is also supplied which should be carried on-board the helicopter.

For your own protection, and for longer bucket life, always read the instructions and warnings. Ignoring these warnings could result in personal injury, bucket damage or aircraft damage.

SEI Industries Ltd. offers complete parts supply and repair services for the Bambi bucket. For a repair facility in your area, please contact SEI.

For maintenance and repair purposes, parts diagrams and descriptions are provided in this manual. When ordering parts, please provide the model and serial number of your Bambi bucket.

There are several other models of buckets available from SEI Industries. These include Bambi bucket model series 6072-1821 and 5566-9800 as well as the Signature series of Bambi buckets.

In addition, a number of accessories and enhancements are also available including the Aqualanche valve, the Torrentula valve, the Powerfill Torrentula system and the Powerfill Snorkel system.

For more copies of this manual, please contact SEI or visit our website at [www.bambibucket.com](http://www.bambibucket.com) for more information on these products.



*Cut away view of standard Bambi bucket.*

## Section 2: Deploying the Bambi Bucket

### Deployment Instructions

#### *Attaching to the Cargo Hook*

##### **Caution**

The Bambi bucket may not be suitable for a direct hook-up to the cargo hook. The actual hook-up will be different for various aircraft and operators must comply with all instructions and bulletins supplied by the aircraft manufacturer. It is the operator's responsibility to ensure that the Bambi bucket is correctly fitted to the helicopter.

The Bambi bucket is rigged for a lateral cargo hook. Correct attachment is indicated when the name plate on the control head faces forward in flight. This ensures that the ballast on the Bambi will also face forward in flight.

##### **Caution**

It is important that the ballast faces forward in flight. This will avoid twisting of the suspension lines and possible jamming of the trip line.

The control head used on models 2024-4453 has a moveable yoke which can be rotated by 90 degrees. The yoke is machined to orient in either direction.

*Hole used when rotating head.*

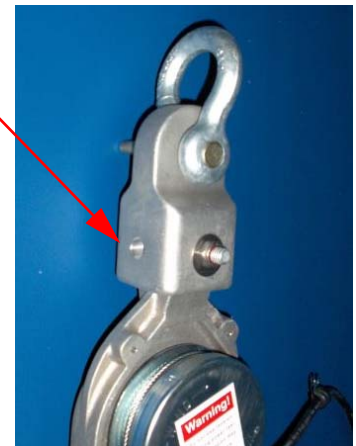

If your helicopter has a longitudinal hook, rotate the shackle yoke unit at the top of the head by 90-degrees. This will place the name plate on the control head forward in flight.

For this style of head, if using a swivel hook, we recommend that you always operate in the locked position to assure that the ballast is always facing forward in flight.

#### Important Note

If you are using a swivel with an electrical connection, then it is acceptable for the bucket to be flown without the ballast facing forward. The Bambi bucket has been tested with some aerospace swivel arms and performs very well despite rotating in flight. The swivel also prevents the suspension lines from twisting up after dipping the bucket.

In some cases, where the cargo hook is too large for the standard shackle, a second larger shackle can be used.

#### Warning

When a second shackle is used to turn the bucket 90 degrees, choose a shackle that is the same size as the shackle on the head. If a very large shackle is used, as shown in the photo below, it may cause the power cable to tangle, pulling apart the break-away plug.

*If the shackle is too large, it may cause the power cable to tangle, pulling apart the break-away plug.*





### Control Head Operation

#### Warning

Do not remove the cover on the control head while operating the Bambi bucket. Part of the tripline safety keeper is cast into the control head cover. With the cover removed, this safety feature is no longer functional. Without the safety keeper functioning, a separated tripline could cause a tail rotor strike which could result in severe injury or death and/or helicopter damage.

For proper operation of the control head, avoid the following modifications:

- Do not use another type of bearing as a replacement for the ball bearing.
- Do not use lockwire as a substitute for the swage blocks on the tripline.
- Do not shorten or change the portion of the tripline which attaches to the reel.
- Do not use threaded bolts as a substitute for clevis pins.
- Do not modify the size or angles of the catch, other than as recommended.
- Do not tighten control head suspension bolts over 5 ft.-lbs. (6.5 Nm).

### Connecting Power

#### Important Note

To operate the solenoid and release the water, use a **momentary contact** switch rated for 5 amps at 24 VDC. A suitable switch is available from SEI Industries. Alternatively, a lower rated switch may be used with a relay (see suggested wiring diagram). The solenoid has a 10% duty cycle (designed to not be operated more than 10% of the time). Operating the solenoid continuously will result in solenoid failure.

The control head of the Bambi bucket comes equipped with a short length of electrical cable. A popular wiring hookup involves fitting a common electrical plug to the end of the cable or whatever matches the plug installed on your aircraft.

To complete the wiring hookup:

1. Connect a plug to the wire supplied on the control head.

2. Make a 12 AWG or heavier two-wire interconnecting electrical cable long enough to run from the bucket cable to the accessory plug on the belly of the helicopter (leave enough length for the control head to swing freely).
3. Attach the mating plug to one end of the interconnecting cable.
4. To check for continuity in the connections, push the momentary contact switch. A clicking sound should be heard from the control head.
5. With the engine running, test for a minimum of 24 VDC at the breakaway plug. If the voltage is lower than 24 volts, use a heavier gauge wire for the interconnecting cable. Re-test to confirm a minimum of 24 VDC at the breakaway plug.

The purpose of the plug is to offer a clean “breakaway” if the Bambi bucket has to be jettisoned from the aircraft in an emergency. It is suggested that the plug be lightly taped together with vinyl tape, while in use, to ensure that wind action does not separate the plug. Current draw is 5 amps (24/28 VDC).

There are four types of suggested wiring installations (see *Section 11: Diagrams*):

1. **Pilot control:** In this configuration, the control is wired into the pilot’s control column through a relay.
2. **Pilot control (US InterAgency):** In this configuration, the control is wired into the pilot’s control column through a 50 amp relay as per US interagency regulations. This system can also be used to control a heli-torch, etc.
3. **Crew control:** This configuration allows a crew member or the pilot to control the dumping of the bucket using power from the helicopter and a remote switch box.
4. **Crew control (remote power supply):** This configuration allows a crew member or the pilot to control the dumping of the bucket using a battery pack to supply the power to the remote switch box.

### Using Longlines

#### Important Note

It is recommended that operators, who choose to use the Bambi bucket with a longline, ensure that the longline is at least 50’ long.

Longlines should be at least 50 ft. long to keep the Bambi bucket well clear of the helicopter’s tail rotor. When using a longline, care must be taken in selecting the correct gauge of control cable. See the chart below for recommendations.

When purchasing a synthetic rope longline, we recommend that the customer also purchase a protective cover and have the conduit inserted at the time of manufacture. However, if this is not feasible due to different conduits for different applications, we recommend taping the conduit using duct tape (grey) at 3-4 ft. intervals along the longline and cover.

We do not recommend using zip ties to attach wiring/conduit as this tends to damage the cover and longline. When attaching conduit, allowances must be made for any stretch in the load bearing line and this must be taken into account when attaching to ensure that the terminations are not released from the belly, bucket or hook, etc.

It is also imperative to take extreme care when removing the conduit from the longline, especially if a knife is used to remove the tape as one could inadvertently cut through the cover and the damage the synthetic rope. It is important to remember that when conduit is duct taped to the outside of a longline, the flight characteristics can change. In our experience, it may take some time and a few trial flights to determine the length between attachment points of the conduit to the longline.

***Longline Wire Details***

LENGTH	GAUGE	TYPE
50 FT.	# 14 GAUGE	14/2 SOW
75 FT.	# 14 GAUGE	14/2 SOW
100 FT.	# 14 GAUGE	14/2 SOW
125 FT.	#12 GAUGE	12/2 SOW
150 FT.	# 12 GAUGE	12/2 SOW
200 FT.	# 12 GAUGE	12/2 SOW

***Checking Suspension Cable Length***



**Warning**

Using a Bambi bucket with a greater overall length than the distance from the cargo hook to the front tip of the tail rotor on your helicopter could result in a tail rotor strike and possible loss of control of the helicopter which could result in injury or death.



Overall lengths of Bambi buckets with standard rigging are provided in this manual. Before using the Bambi bucket, check for the maximum total length. To determine this length, measure the distance from the cargo hook to the front tip of the tail rotor on the helicopter you will be using and subtract 6” (152 mm).

To determine overall bucket length:

1. Stretch out the bucket on the ground; secure the control head.
2. Pull out the dump valve fully; pulling taut to ensure the suspension cables are straight

Bambi Model	Overall Length	
	Feet	Meters
2024	19' 5"	5.92
2024S	15' 2"	4.62
2226	15' 5"	4.70
2732	23' 0"	7.01
2732S	15' 3"	4.65
3542	23' 5"	7.14
4453	23' 8"	7.21

*Lengths are accurate to within 1%.  
Note: Specifications subject to change.*

**Important Note**

If a firesock is being used, add 9" (230 mm) to the overall length shown the above chart.

3. If the Firesock is to be used, attach first and then measure to the bottom of the sock.

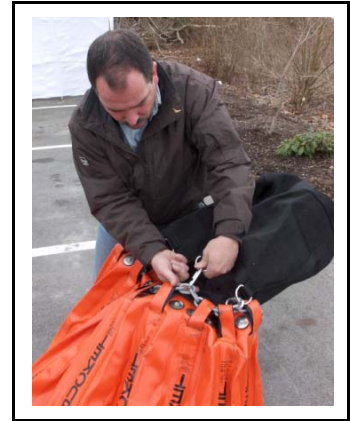

4. Measure the distance from the shackle on the control head to the bottom of the dump valve. This measurement should be less than the maximum total length of the dimension taken from the helicopter.

#### Important Note

To avoid potential rotor strikes when using the Bambi bucket, the operator must measure the extended length of the Bambi bucket and the distance from the belly hook to the closest possible point of the tail rotor.

A) Always measure the overall extended length of your Bambi bucket.

*and*

B) Measure the distance from the belly hook to the closest possible point on the tail rotor.

**"B" must always exceed "A" by at least six (6) inches.**

## Instant Deployment System (IDS)

The instant deployment system uses a hub and spoke mechanism to automatically expand the mouth of the bucket as soon as the weight of the Bambi bucket is taken up by the suspension cables. When the bucket is full, the IDS deployment cable and hub restrainer cables should be slack as they should not bear any load. Their function is to position the hub and spoke mechanism to hold the bucket open.

The main parts of the IDS are illustrated in this manual for maintenance purposes. To deploy the IDS on the ground, reach into the bucket, grasp the hub of the IDS and pull outward fully until the two restraining cables from the hub to the lower bucket shell are tight.

The IDS restraining cables are set at the factory and normally should not require any adjustment.

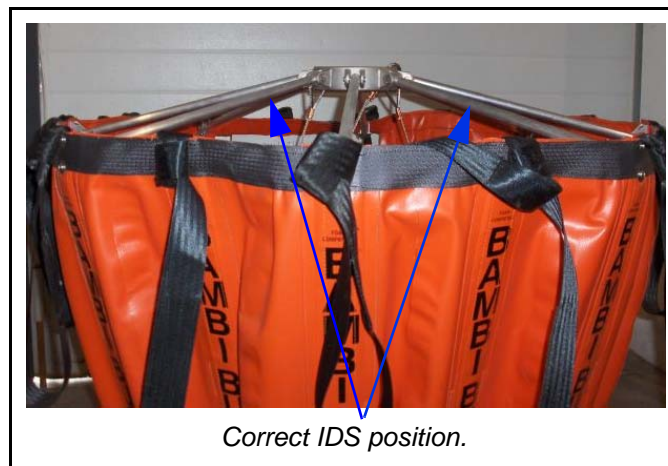

## Section 3: Using Accessories

### Using Foam

The Bambi bucket is designed to be effective with foam. All materials used in the manufacture of the Bambi bucket are resistant to the chemical action of foam.

#### Caution

After using foam or retardants, cycle through several dumps with water only or hose down with fresh water. This will prolong the bucket life.

#### Sacksafoam Foam Injection System

The Sacksafoam is SEI Industries' advanced foam dispensing system for use with the Bambi bucket. This system, exclusive to the Bambi, allows foam to be dispensed into the bucket in route from the filling source to the fire site.

There are three models of Sacksafoam to fit this range of Bambi buckets. The operation of the Sacksafoam is controlled by the pilot through a control unit, which is mounted in the cockpit. Sacksafoam I contains the foam reservoir directly installed inside the bucket.

The Sacksafoam II is a self-contained unit that can be stowed onboard the helicopter. This system is completely housed in a foam-resistant case. With the Sacksafoam II, the pilot still controls the foam dispensing through the control unit.



*Sacksafoam I*



*Sacksafoam II, Model 5598*



Sacksafoam Plus

If additional foam storage is required, the Sacksafoam Plus can be purchased to add an additional 40 gallons of foam on board.

**Compatible Bambi Bucket/Sacksafoam Models**

Model	For Bambi Bucket	Reservoir Capacity	
		USG	Liters
<b>Sacksafoam I</b>			
SFF01-2044	2044-4453	30	114
<b>Sacksafoam II</b>			
SFF02-5598	1821-4453	25	94
<b>Sacksafoam Plus</b> (for additional foam storage for SFII and SFIII)			
SFF-Plus		40	151



## Using the Firesock



The Firesock, when attached to the bottom of a Bambi bucket, makes the bucket a more effective tool by increasing the aeration of the foam when using a Sacksafoam injection system.

The Firesock breaks down water droplets (thereby increasing the exposed surface area) when using straight water. The simple design allows for improved coverage and increased drop accuracy as well as wider and longer drop patterns.

To use your Firesock, simply attach the quick connect links onto the bottom chain and it's ready for action.

When finished using it, make sure to:

- Inspect the Firesock before next use.
- Clean the Firesock using fresh water.
- Store the Firesock, attached to the Bambi bucket, ensuring both are dry.

The Firesock is an optional item and is not included with the Bambi bucket.

## Section 4: Making Adjustments

### Adjusting Various Components

#### ***Adjusting the Dump Valve Udder***

Udder refers to the amount that the dump valve bulges out below the bucket shell, when the bucket is full. Dump valve udder adjustment has a significant effect on the valve seal between the fabric dump valve itself and the bucket shell. This adjustment is carried out by lengthening or shortening the tripline adjustment chain.

Ninety percent of the dump valve seal is produced by the stainless steel bolts passing through the neoprene foam and the bucket. The balance of the sealing action is a result of the valve “uddering” out the bottom of the bucket and compressing the foam between the valve and the bucket.

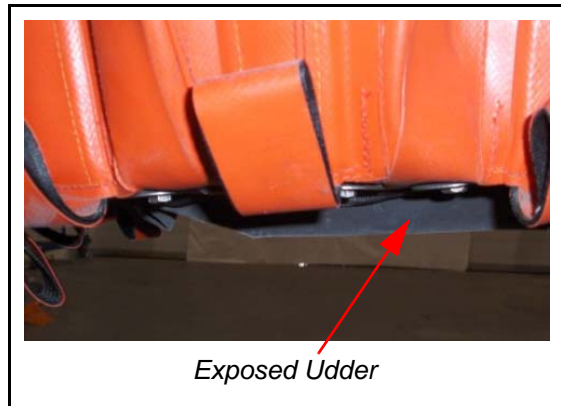

A properly adjusted dump valve will have a maximum of 2" (50 mm) of udder. Too much udder will add to the volume and thus the weight of the bucket. Too little udder will prevent the secondary sealing action and will result in the valve leaking.

#### ***Adjusting the Udder via the Tripline***

Each new Bambi bucket is adjusted and checked at the factory under full fill for proper dump valve adjustment. To adjust the udder, change the length of the tripline by adjusting it at the tripline adjustment chain.

The method of securing the ring and riser is to secure the adjustment chain to a shackle that is attached to the tripline.

If a new tripline is installed, first install it at the same point on the adjustment chain and then test the dump valve in use. Remember to secure the adjustment shackle with a lockwire or tie wrap first. It is impossible to judge udder with an empty bucket on the ground.

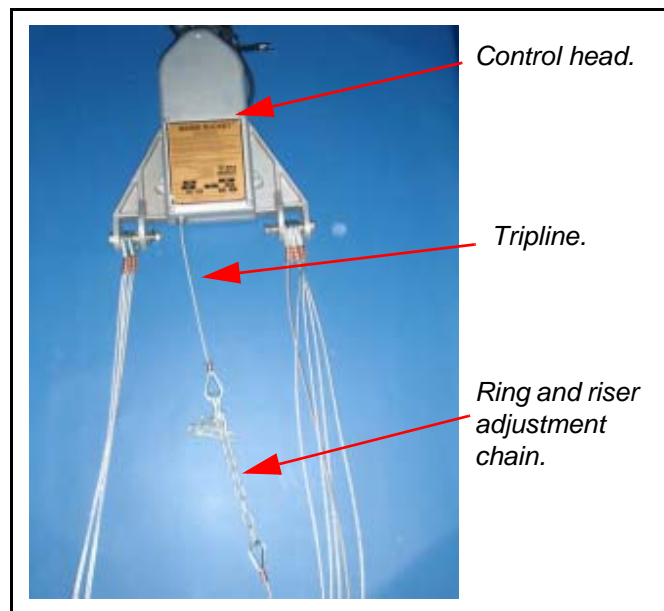

### ***Adjusting Purse Strings in the Dump Valve***

Adjustment of the purse string in the dump valve is important to effect a good seal at the neoprene lips of the valve mouth. The purse line adjustment is set and tested at the factory. The purse string may shrink or stretch after use and require adjustment.

Whenever new purse strings are installed, adjustments must be made. Braided nylon is specified for purse string use since it is self-lubricating under water.

When installing a new set of purse strings, orientate the valve correctly and always make sure to stagger the strings from side to side. Check *Section 8: Maintenance* for full purse string instructions.



*Note the staggered purse strings.*

#### **Important Note**

When initially tying up the purse strings, note that more tension should be on the outside string with progressively less tension towards the middle. If the tension is too great on the middle string, the valve action will be sluggish when the valve is retracting. All strings have a black mark; this mark should be tied at the inside of the ring.

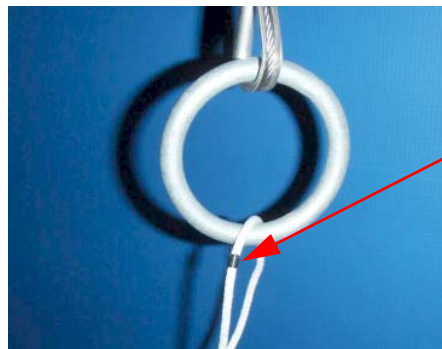

*Black tie mark*

***To adjust a single line:***

1. Simply adjust the tension of the line to equal that of adjacent lines. Repeat the knot shown three times for each purse string.

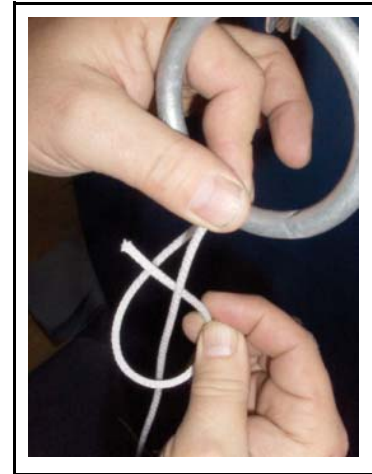
***To adjust all the lines:***

1. Stand the bucket vertically.
2. With the valve bottom flat on the floor, pull the bucket shell into a round shape by deploying the IDS.
3. Run a rope from an overhead support to the ring on the top of the valve.
4. Proceed to adjust the string.

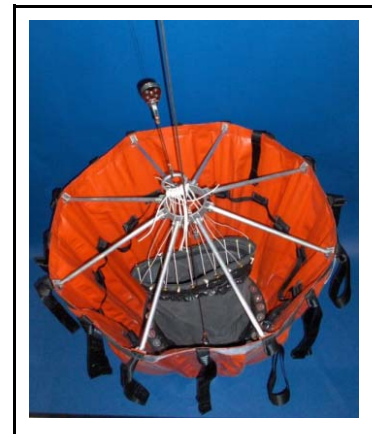
***Checking Purse Line Adjustment***

Once the lines are adjusted, fill the Bambi bucket half full, with the water, just below the top of the valve. Check to see if both lips of the valve are matched right across the top. Sometimes, one lip will 'track' slightly above or below the other.

Usually, one or two specific purse lines will cause this improper tracking. To correct:

1. Grasp the purse lines at the centre of the lower side.
2. Pull the strings several times to bring the lip into alignment.
3. Re-tie the purse lines so that the line is just snug. Do not over-tension the line. Over-tensioning will result in misalignment at another position on the valve.

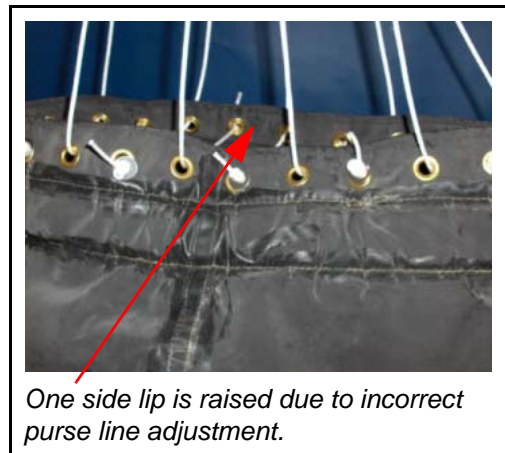

## Section 5: Packing and Storage

### Packing and Storing

#### *Packing the Bucket*

1. Collapse the IDS by pushing the hub into the bucket.



2. Grab the control head and pull the suspension lines taut. Tape the lines together in two bunches.



3. Insert the operations manual and control head into the storage bag.



4. Gather the suspension lines into a coil and stow inside the bucket. Place the control head outside of the bucket to prevent the possibility of the lines tangling.



5. Avoid any sharp folds along the base of the shell as this protects the shell from delamination which can occur if the Bambi bucket is stored for a long period of time.



6. Place the control head bag on top of the collapsed bucket.



7. Roll the bucket into a bundle and wrap with straps supplied.



8. Take the carrying bag and drape it over the bucket.



9. Roll the bucket over and insert the bucket and Firesock into the bag.



The Bambi bucket carrying bag makes a suitable shipping container when shipping via airfreight. Because of the compactness of the Bambi, many operators carry it aboard the helicopter, at all times, during the fire season. This allows for rapid deployment when required.

### ***Storing the Bambi Bucket***

The following guidelines will help to ensure the longevity of your Bambi bucket:

1. Do not pile heavy objects on the Bambi bucket in storage. This may result in creases in the neoprene seal in the dump valve, which may cause leakage.
2. Wash the bucket and allow it to dry prior to storing it.
3. Do not store a wet bucket. This will result in the growth of mildew and the corrosion of aluminium and steel parts.
4. Store the bucket indoors in an unfolded position, preferably by suspending the main shackle from an overhead hook. An alternative is to suspend the bucket upside down from its bottom chain.
5. Before storing the bucket for an extended period, perform the seasonal maintenance procedures as outlined in *Section 8: Maintenance*.



## Section 6: Troubleshooting Guide

### General Troubleshooting Guide

#### *Valve Troubleshooting*

Problem	Possible Cause	Solution
Leaking dump valve	Over tightening of FCAS (cinch strap) affecting seal.	Re-adjust cinch strap.
	Lack of seal between valve and bucket shell.	Apply butyl rubber sealant.
	Creases or deterioration in the foam lips of the dump valve.	Work out creases or replace valve.
	Misaligned purse lines.	Adjust purse lines.

**Control Head Troubleshooting**

Problem	Possible Cause	Solution
Head doesn't release dump valve	Solenoid malfunction	Check the electrical connections for proper operation of the solenoid. A click should be heard when the circuit is closed. See picture 1 on the following pages.
		Check the white wires on the solenoid for shorting. Check terminal block for loose wires.
		Check for a burned-out solenoid, measured with an ohmmeter, the solenoid should have about 5.7 ohms resistance. A higher resistance may indicate a poor connection or a burned out solenoid. A lower resistance may indicate a shorted-out solenoid coil.
	Jammed linkage	With the cover plate removed, activate the solenoid and check for jamming of linkage. Check terminal block for loose wires. See picture 1 on the following pages.
		The tail of the catch may ride up on the bearing. Activate solenoid to release. See picture 3 on following pages.
		Check that the spring link is resting on the body of the stop bolt and not on the head of the bolt, with the control head sitting vertically. See picture 2 on the following pages.
		Check the catch for burrs at the bearing or the point. The point can be worn by the passage of the trip line bullet. Remove burrs with a fine file. See pictures 4 and 7 on the following pages. Check for rifling in the trip block and deformation on the top of the bullet.
Head releases dump valve prematurely	Loose trip block bolts	Tighten trip block bolts. See picture 5 on the following pages.
	Links are above center	Check that links are below center line of clevis pins. Adjust links. See picture 6 on the following pages.
	Worn catch at point	Check the catch point for wear at the bullet. Replace catch. See picture 7 on the following pages.
Tripline jams on returning	Tripline sleeves are fouling cast lugs on head.	Pull the tripline completely out. Check that the swaged sleeves at the end of the tripline are not fouling the cast guide lugs on the head and cover. Round the end of the swage sleeves with a file. If necessary the lower set of cast lugs (closest to the trip block) on the head act as a safety keeper to prevent a tripline broken at the top end from causing a tail rotor strike. The swage blocks should not pass between them. See picture 8 on the following pages.
Tripline doesn't return	Broken spring in reel	Check for a broken spring in the reel. A broken spring is indicated if the tension on the reel doesn't increase as the reel is wound, or if the tension increases in jerks or the spring seems to "slip" inside the reel. See Spring Power Reel Replacement for reel replacement procedure.

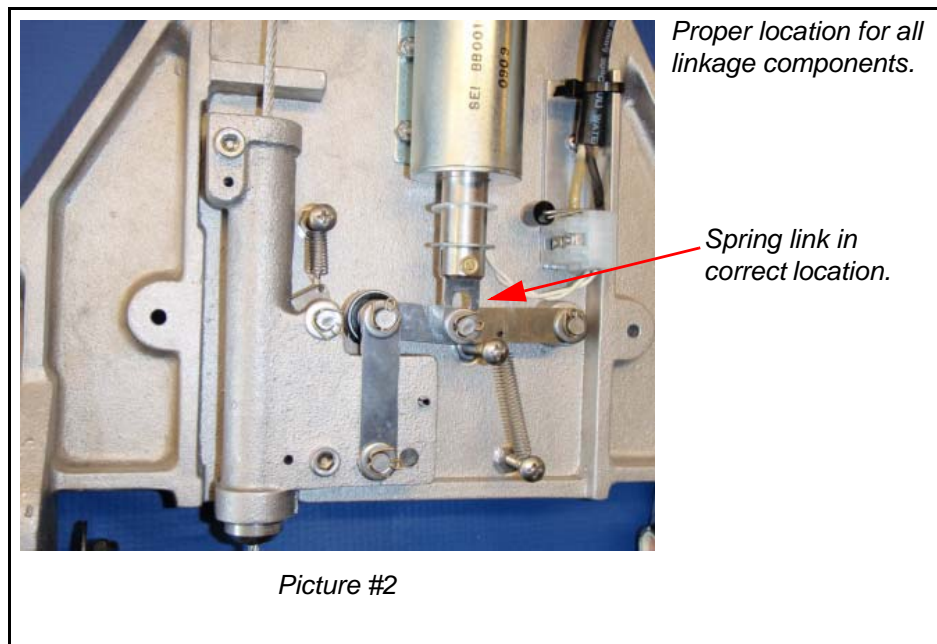
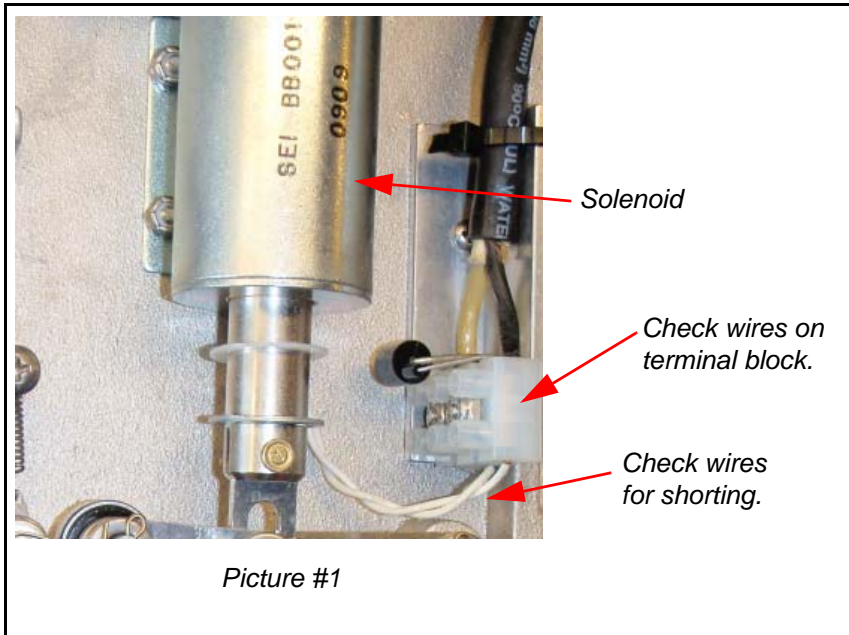

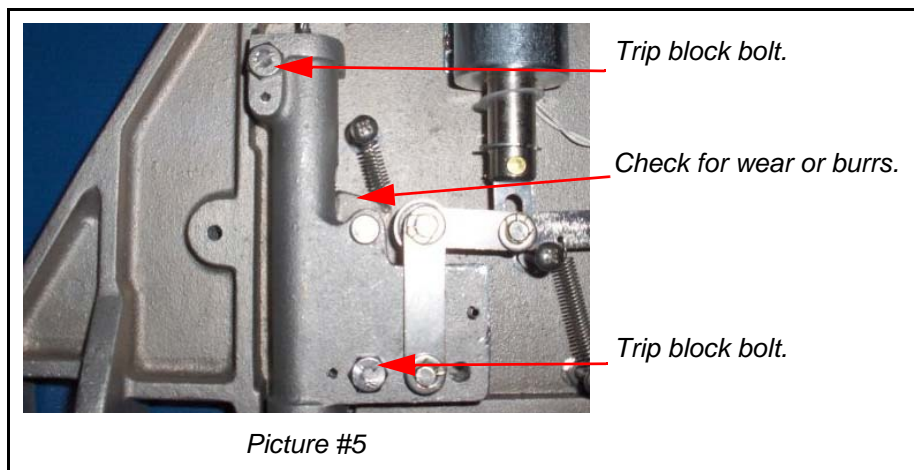
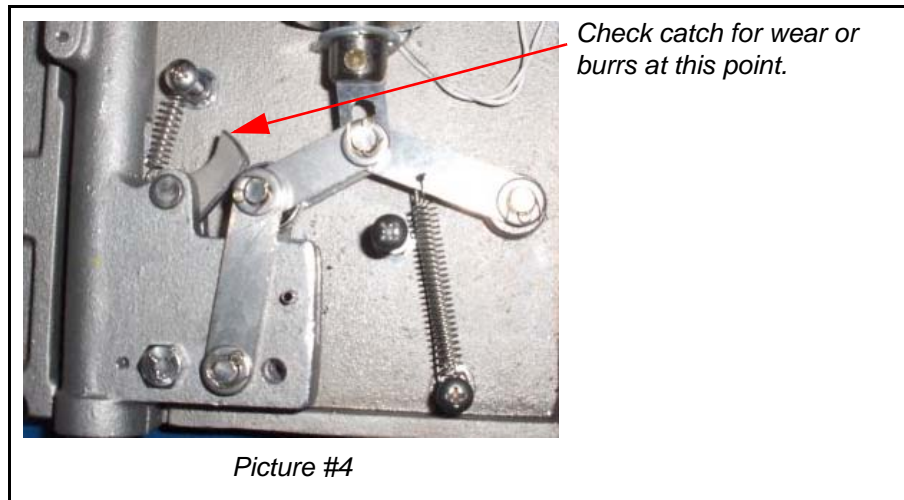
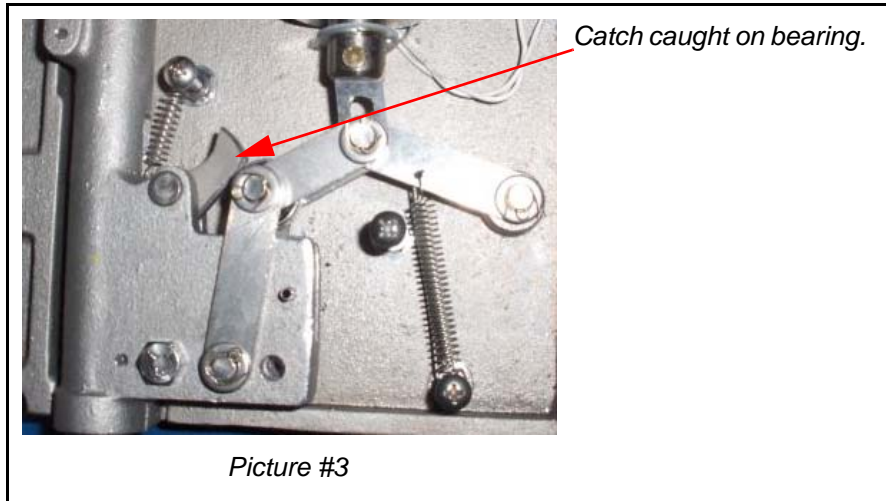

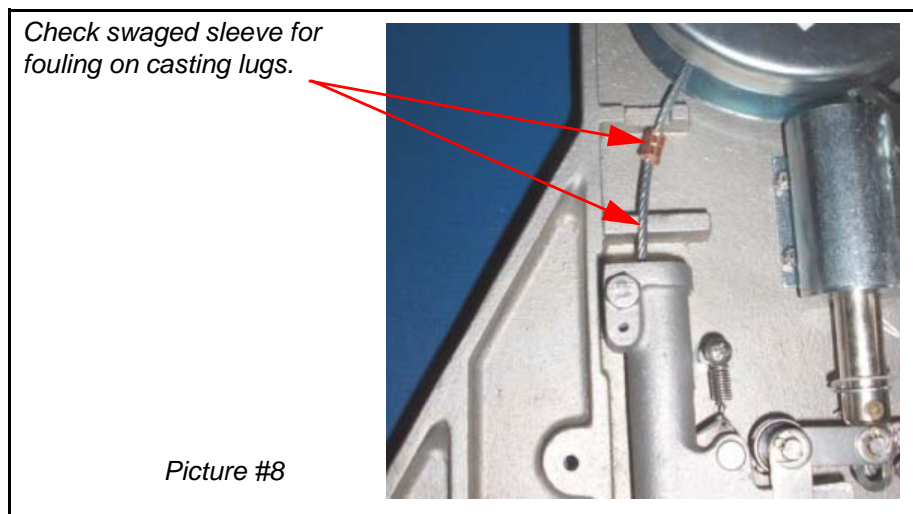
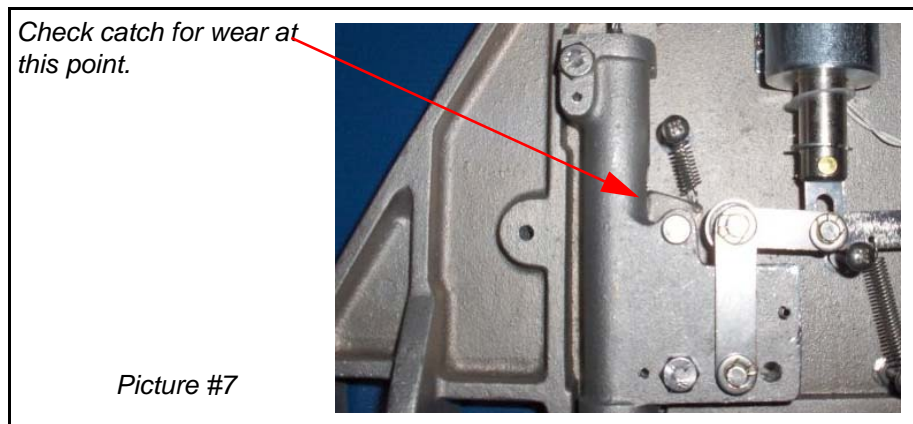
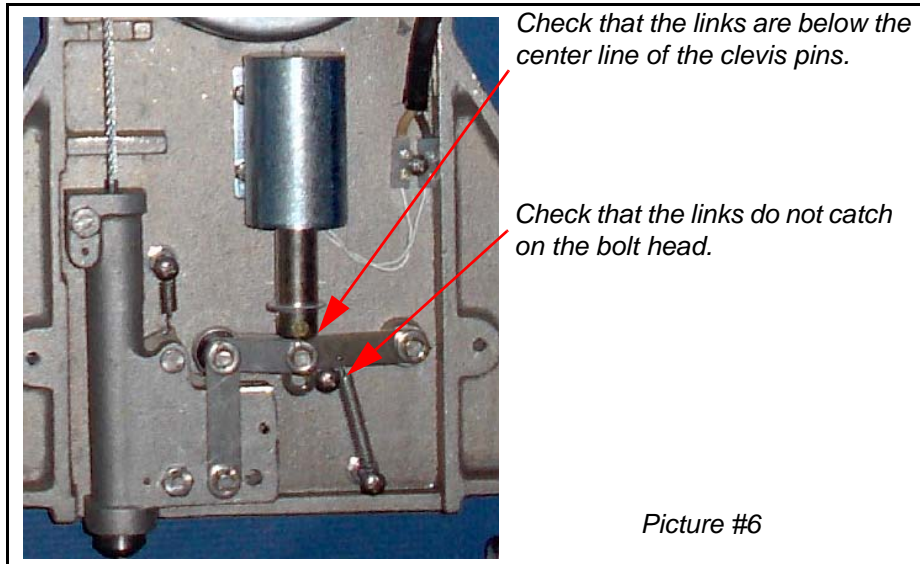

## Section 7: Control Head Maintenance

### Operation and Maintenance

#### Control Head Operation

##### Warning

Do not remove the cover on the control head while operating the Bambi bucket. Part of the trip line safety keeper is cast into the control head cover. With the cover removed, this safety feature is no longer functional. Without the safety keeper functioning, a separated trip line could cause a tail rotor strike which could result in severe injury or death and/or helicopter damage.

For proper operation, nuts and bolts should be tightened until a sharp rise in torque is felt. Avoid the following modifications:

- Do not use another type of bearing as a replacement for the ball bearing.
- Do not use lockwire as a substitute for the swage blocks on the trip line.
- Do not shorten or change the portion of the trip line which attaches to the reel.
- Do not use threaded bolts as a substitute for clevis pins.
- Do not modify the size or angles of the catch, other than as recommended.
- Do not tighten control head suspension bolts over 5 ft-lbs. (6.5 Nm).

### Tripline Replacement

The tripline should be examined daily for kinks, frays or loose swages. Replace the tripline as soon as any deterioration is observed.

##### Caution

Accidental release of a wound spring reel can result in injury to your hands. Wear gloves and use caution when winding the spring reel or pulling the tripline.

**Removing the Old Tripline****Important Note**

It is recommended that you study how the tripline is installed before removing it. This will make it easier to understand the following directions.

1. If possible, secure the head in a clamp, as shown.



2. If the tripline is not broken above the trip block and the spring reel is functional, push the solenoid up releasing the catch and pull the tripline out to its full extent.



- Secure the spring reel to prevent the reel from unwinding. This can be done by clamping a small pair of vice-grips onto the bottom flange of the reel, locking the reel against the solenoid.



- Using needle nose pliers, create slack in the cable by pulling the copper swage close to the drum.

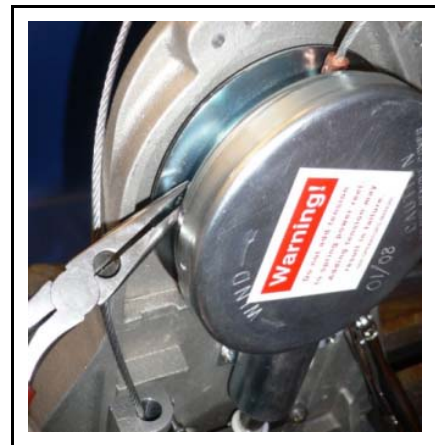

- Use a small screwdriver and a stiff wire through the hole in the spring reel drum to remove the end of the tripline from the locking finger.





6. The photo shows the tripline end being pulled from the reel.

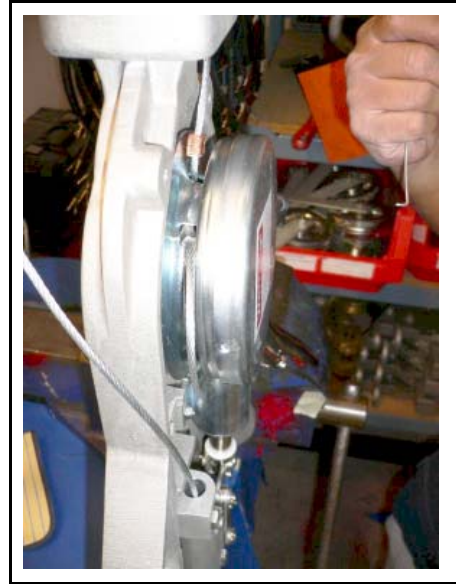

### ***Winding the Spring Reel***

If the spring reel tension has been released, the spring reel must be re-wound before the new tripline is installed.

1. Wind the spring reel in the direction indicated by the arrow stamped on the cover to its maximum, then back off until the three holes in the reel are positioned at the top (approximately one full turn).
2. Secure with vice grips to prevent the reel from unwinding.

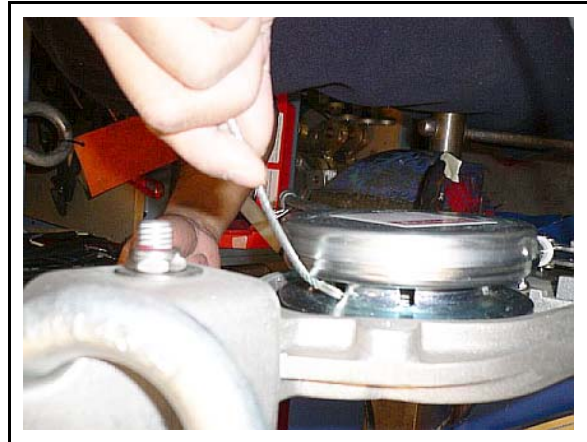

### ***Installing a New Tripline***

Before installing, check the trip block for grooves or rifling. Also, check that the bullet moves freely. If it does not, ream out the trip block.

1. Pass the tripline through the trip block's bottom hole upwards to the top.

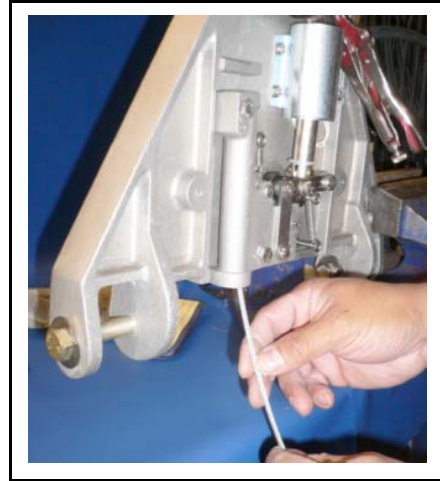

2. Once the tripline has passed through the trip block, bend the end of the tripline into a tight spiral using a pair of pliers.



3. Insert the end of the tripline through the large center hole of the drum. Fish the tripline out through the small hole to the right of the center hole using a flat screw driver. Guide the end of the swage block out through the hole.

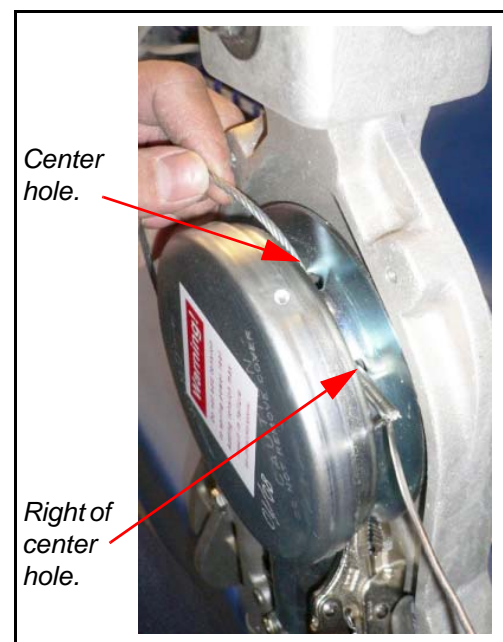

4. Pull 12-14" (30-35 cm) of line from the hole and pull it around the drum in a clockwise motion. Insert the tripline into the small hole to the left of the larger hole, when facing the head.

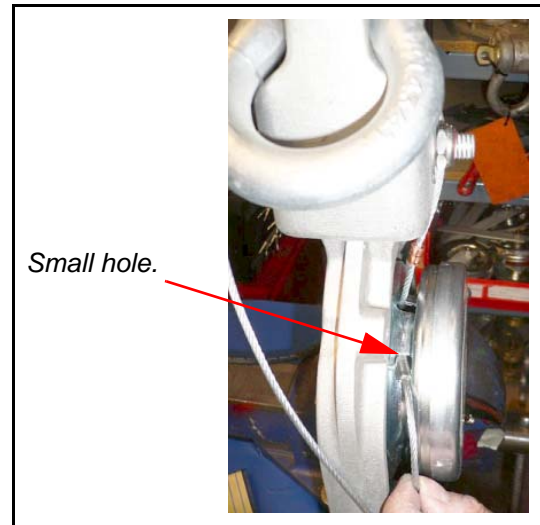

5. Locate the locking finger in the large center hole of the reel. Push the swage on the end of the tripline past this locking finger.



6. Pull the line up and over the finger and into the slot between the finger and the drum. To assist in this step:
  - Bend a piece of lockwire into a U shape.
  - Insert the bent end of the U into the large center hole of the reel.
  - Push the tripline through the U and past the finger on the reel.
  - Pull on the lockwire to lift the tripline outward past the finger.
  - Push the tripline into the slot.
  - Remove the lockwire.

7. Pull the free end of the tripline to remove any slack around the drum. Loop the cable behind the yoke to assist in this operation. Once completed, return the cable to the front of the head.



#### Important Note

Ensure that the swage blocks, at the end of the tripline, lie behind the section of tripline that passes through the centre hole to one outside hole. If the swage blocks lie outside the section of wire, they may foul the two cast lugs on the head which orientate the reel anti-torque plate. This will stop the tripline from winding up onto the reel.

8. With the tripline fully connected to the drum, note that there is a swage block about 1-2" (2-5 cm) from the drum. This block will be stopped by the safety keeper cast into the head. If the tripline should break where it enters the reel drum, the swage block will ensure that the tripline cannot come free of the control head.

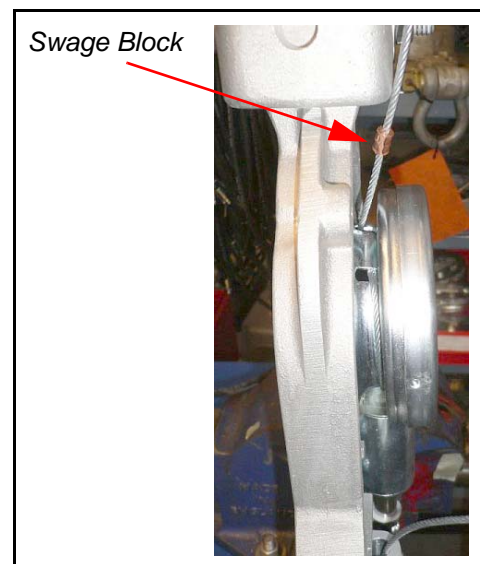

9. While holding the reel securely, release the temporary lock. Allow the cable to wind in gradually. Do not let the reel free-wheel. **Use gloves to protect your hands from injury.**



## Spring Power Reel Replacement

### *Removing Old Spring Reel*

#### **Caution**

The spring reel must be unwound before its securing nut is loosened. Loosening the nut on a wound spring reel could result in damage to the reel and/or injury to your hands.

1. Remove the tripline as per *Tripline Replacement* instructions in this manual.
2. Wear gloves to protect your hands. Hold the spring reel firmly and remove the clamp or other locking device. Release the tension gradually until the reel is completely unwound.

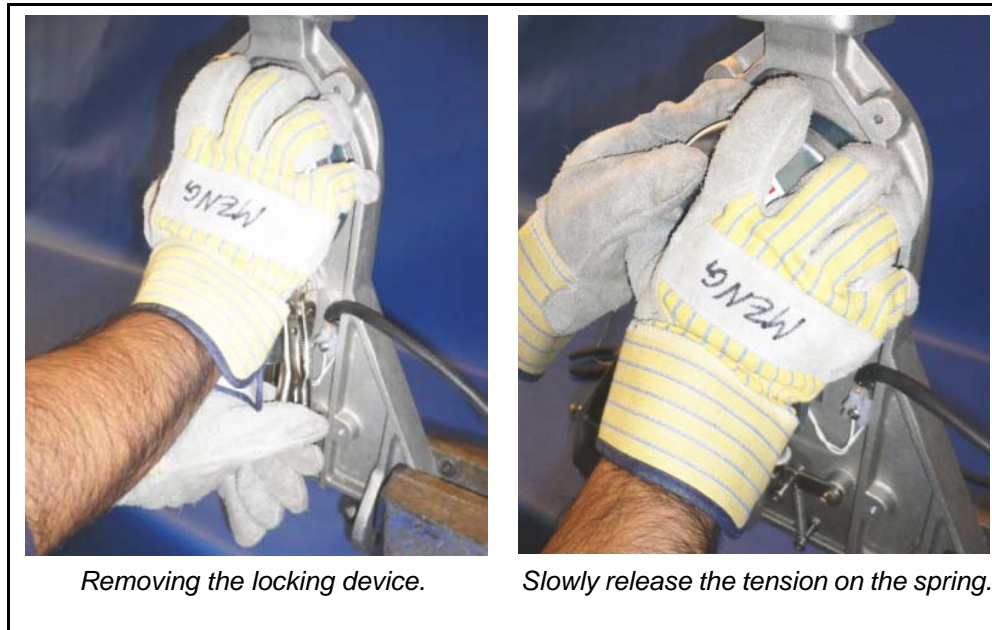

3. Locate the spring reel locking nut on the back of the control head.
4. Remove the locking nut and then the spring reel. Make sure to hold the threaded bolt with an Allen key when removing the nut.

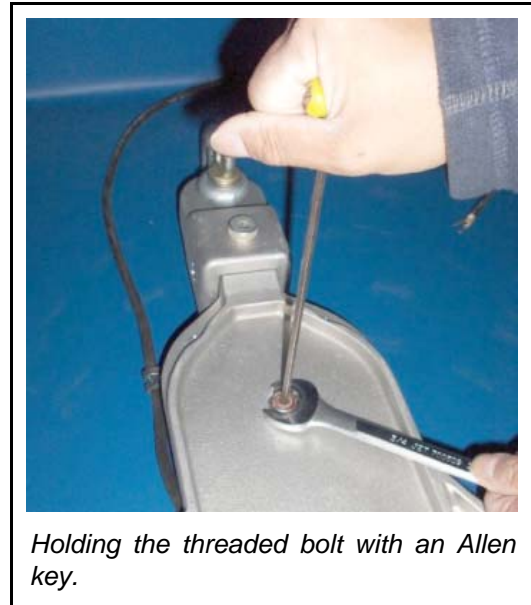

**Important Note**

Note the position of the anti-torque plate on the back of the spring reel. The spring reel must be installed with the anti-torque plate positioned between the two lugs, cast in the control head.

*Anti-torque plate.*



*Locking lugs.*

5. When fitting the new spring reel, check the clearance between the reel and the control head. There must be a gap of approximately 1/8" (3 mm) to prevent rubbing. Older fabricated heads may require spacer washers, under the spring reel, to achieve the required clearance.
6. Install the spring reel locking nut. Use an Allen key to prevent the reel shaft from turning. Tighten the reel locking nut to 40 ft-lbs (55 nm).
7. Use Loctite to prevent the locking nut from loosening.

**Important Note**

The new spring reel is supplied with a vinyl coated cable attached. This vinyl coated cable must NOT be used as a tripline.

8. Disconnect the elastic band on the vinyl coated cable and slowly pull the cable off the reel.



9. Lock the reel with vise grips.



10. Wrap the vinyl covered cable back around the spring reel. Remove the temporary lock and, again, pull the cable out until the reel stops.





11. Back the spring reel off until the three holes are positioned at the top (approx. one full turn) and secure the reel.
12. Remove the vinyl covered cable and discard. Re-install the tripline (see instructions on replacing triplines).

### Catch Replacement

Newer buckets use a standardized catch and trip block which should not require the following procedure when replacing the catch. However, when replacing the catch in older buckets (manufactured before June 1993), use the following procedure.

1. Check the tripline for play in the tube and snug up swage sleeves with a swaging tool, if necessary, to ensure the tube is snug between the bullets.
2. Remove the catch spring.

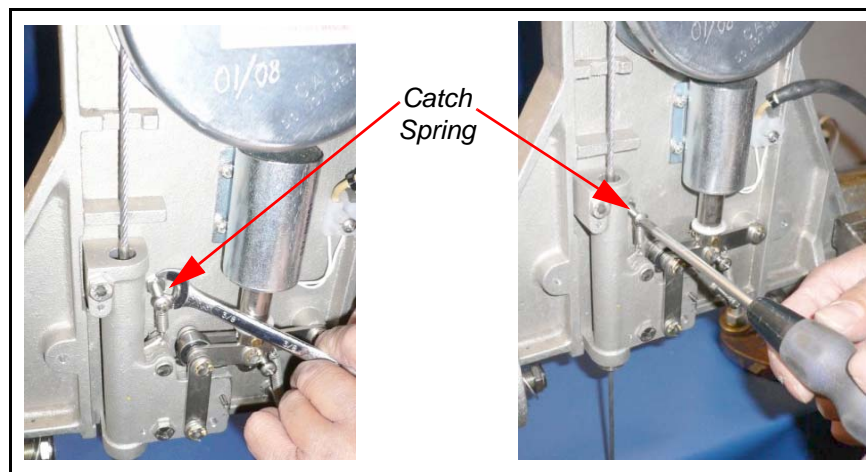

3. Remove the bottom cotter pin on the catch clevis pin. Then, remove the catch clevis pin and the damaged catch by inserting an awl into the cotter pin eye and prying it out. Remove the catch clevis pin. Remove the catch and spring assembly.



4. Attach the spring to the new catch as shown.



5. With the tripline installed, place the new blank catch in its slot and slide the point in against the tube on the tripline. Keep the tail of the catch in place under the ball bearing and insert the clevis pin.
6. When installing the catch with the catch clevis pin, check that the point just touches the tube on the tripline.
7. Install the bolt, holding the spring in tension, and tighten the jam nut.
8. If your head was built prior to 1993, you may have to perform the following procedures to make the catch work.
  - If the pin will not insert into the catch hole, note the amount that must be filed off the point of the catch to allow the hole in the catch to fit through the hole in the trip block. File or grind off the point of the catch in a radius centered on the hole in the catch. Keep the ground point square to the faces of the catch. Round the corners of the filed point smoothly to remove burrs.
  - When the solenoid retracts, the tail of the catch must clear the bearing in order for the tripline to be released. Operate the solenoid by hand to check that the tail of the catch will clear the bearing. If it does not, remove the catch and grind the tail of the catch so that it will clear the bearing. File edges just enough to remove any burrs.

## Section 8: General Maintenance and Repairs

### Maintenance and Repairs

#### Purse Line Replacement

The purse line specifications for various models of Bambi buckets are provided in the table below. The tie length refers to the distance from the fender washer up to the top side of the lower section of the ring used to secure the purse lines.

The purse lines alternate from one side of the valve to the other. When threading the valve, insert the first purse line from one side. The next purse line is inserted from the opposite side. Any or all lines replaced should follow the same sequence. Refer to *Adjusting Purse Lines* in this manual. Braided nylon for new purse lines can usually be purchased locally. Make sure to use nylon since it is self-lubricating in water. After cutting the new line, melt the ends with a lighter to prevent fraying. Tie a knot on the end of a new line large enough to prevent passage of the line through the fender washer.

#### Purse Line Specifications

Bambi Model	Purse Line Dia.	Cut Length	Approx. Tie Length
2024-3542	#5-5/32" (4.0 mm)	49" (1244 mm)	33" (838 mm)
4453	#6-3/16" (4.8 mm)	52" (1320 mm)	37" (940 mm)

#### To replace all purse lines:

1. Ensure the valve grommets are aligned properly. The two pairs of grommets, with a larger space between them, serve to indicate where the valve is folded. When folded correctly all the grommets will line up. When the valve is correctly installed in the bucket, the folded seal will be parallel to the ballast.

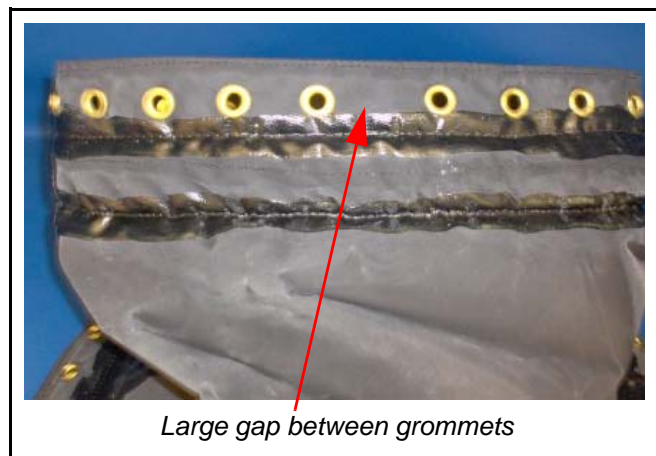

2. Ensure the new purse lines are melted at the loose end and have a large enough knot to be secured at the fender washer.
3. If you are using new SEI-supplied purse strings, note the black mark. This mark is centred on the ring when tying. If you are using uncut nylon line, place a mark at the approximate tie length based on the chart on the previous page.

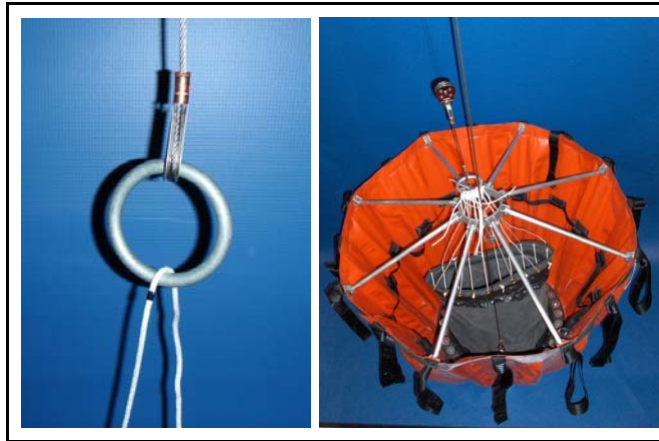

4. Thread the purse lines, alternating from one side of the valve to the other.
5. Starting from one end-fold of the valve, tie the purse line to the metal ring at the mark with a round turn and three half hitches.

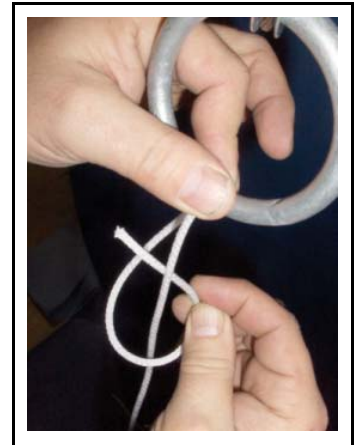

6. Work towards the other end, tying the lines with equal tension from alternate sides of the ring.

Further details on purse line adjustments are given in *Adjusting Purse Lines* in this manual.

#### Important Note

The best valve sealing action is created when the outside lines of the valve have slightly greater tension than the inside lines.

### ***Suspension Line Replacement***

A suspension line should be replaced whenever it displays noticeable kinking or fraying. Factory replacement lines come pre-swaged with connection links to make replacing quick and easy.

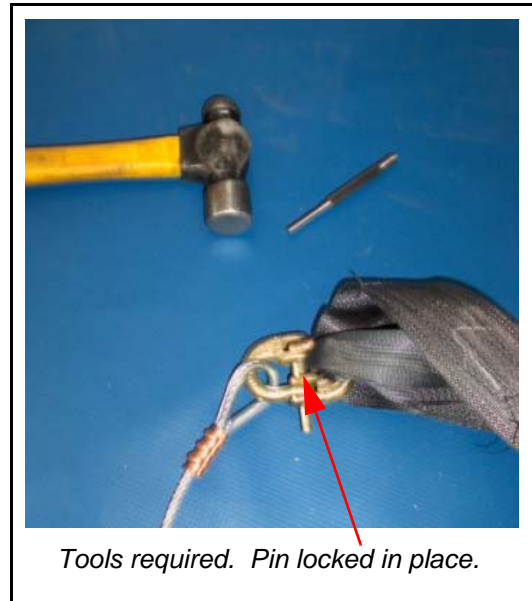

To remove the connecting link (connecting the suspension line to the M-strap) follow the procedures outlined below.

1. Locate a metal bar with a 5/16" hole (or drill a 5/16" hole into any metal bar). If you are unable to locate a metal bar, a wooden block will work, however, make sure to drill the hole into the end grain.



2. Place the connecting link with the pin located over the hole and using a 3/16" punch, drive pin through the center holding sleeve.

3. After the pin is free, remove the old suspension line. Place the new line in the connecting link by inserting the pin into one side of the connecting link. Using a hammer, drive the pin in until it is flush with both sides of the connecting link.

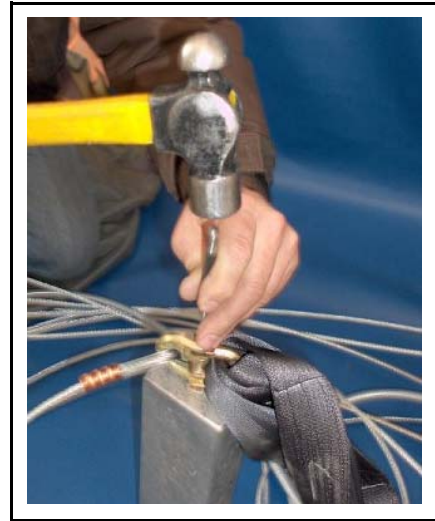

### ***M-Strap Replacement***

Replace M-straps if they become noticeably worn. M-straps may be repaired, if frayed, by melting the fray with a lighter to stop the fray from spreading. The length of the M-strap is critical to the proper functioning of the Bambi bucket and we recommend that you replace worn straps with factory-supplied equipment.

There are two types of straps; long webbing and short webbing. Long webbing are used for the diagonal straps while short webbing are used for the vertical straps.

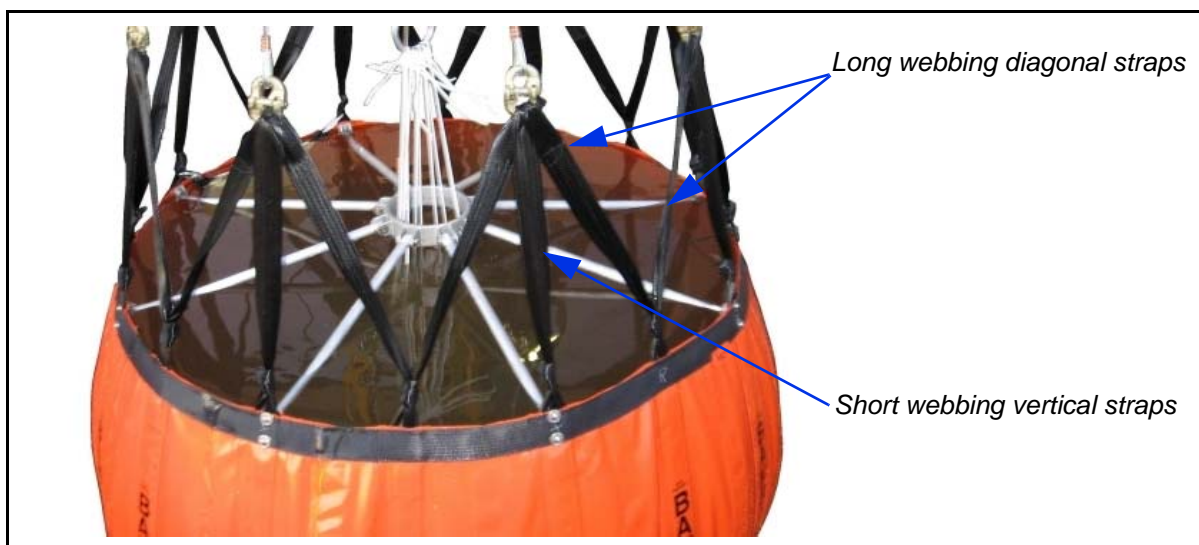

When replacing straps, do one set at a time to avoid confusion. Cut off the old straps from the shackle and un-tie them from the top of the bucket shell. Attach replacement straps as per the originals.

**Removing Old M-Straps**

1. Using needle nose pliers, insert the tip under the top webbing layer.

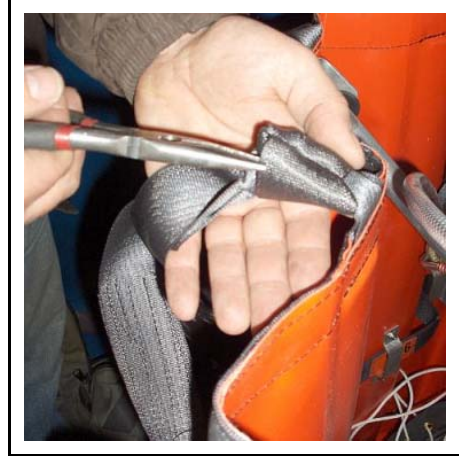

2. Fully insert the pliers at the far left hand side of the top layer.



3. Holding the pliers tight, turn your hand clockwise. Repeat the operation until the knot is loose enough to remove the strap.



***Installing New M-Straps (Short)***

Once the old straps have been removed, the new strap installation can begin.

1. Rotate the strap until the joint is centered.



2. Pass the strap through the loop.



3. Twist the loop eye 180 degrees.





4. Rotate the eye to the opposite side.



5. Pull strap end through the eye.



6. Pull strap tight.



***Installing New M-Straps (Long)***

Once the old straps have been removed, the new strap installation can begin.

1. Locate the center of the strap.



2. Pass the strap through the loop.



3. Twist the loop eye 180 degrees.



4. Rotate the eye to the opposite side.



5. Pull strap end through the eye.



6. Pull the strap tight.



7. The M strap set should now look like this. The suspension line attaches to the top of each M-strap set.



### ***Dump Valve Replacement***

SEI Industries replacement dump valves come complete with new purse lines, bolts, nuts, washers and butyl rubber sealant.

To replace a valve:

1. Remove the old valve as well as all butyl tape and ballast
2. Stand the bucket up with the valve hole on the bottom.
3. Apply a 1/2" x 1/8" (13 mm x 3 mm) bead of butyl rubber sealant in a circle around the inside of the bucket shell, just below the valve grommets, to make a seal between the shell fabric and the dump valve fabric.
4. Place the large stainless washer and then the rubber washer onto the bolt. Insert the bolt up from outside of shell.



5. Close the mouth of the new valve.
6. There are two grommets at the top of the valve at opposite sides that are spaced further apart. This is where the valve folds flat. When the valve is folded flat, the seam will be in the middle of the top or bottom surface and the grommets at the top will line up.

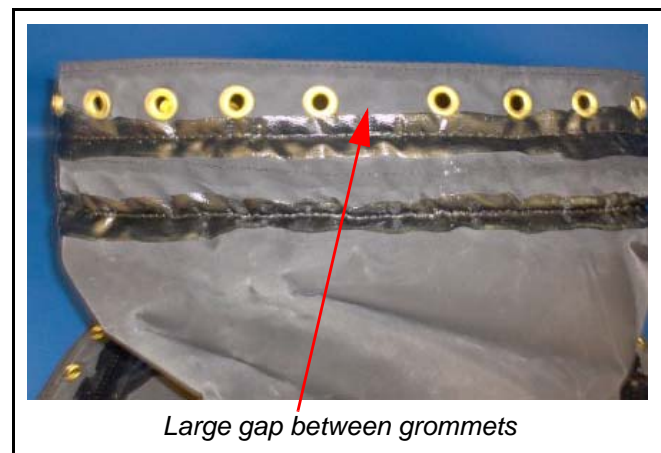

7. Place the new valve into the bucket with the valve mouth (when closed) parallel to the ballast pouch location (see picture). If the valve is not aligned correctly, leakage will occur.
8. Install the fastenings and snug up the nuts until two threads on the bolts show. Do not overtighten.
9. If the purse lines require tying or adjustment, refer to the instructions *Adjusting Purse Lines* and/or *Purse Line Replacement*.



*Ballast Pouch Location*

### ***Bottom Loop Repairs***

If the bottom loops, which hold the chain, become worn, the frays can be melted with a lighter to prevent them from spreading. If the bottom loops require replacement, they should receive an overlay of heavy duty wear-resistant webbing.

### ***Bucket Patching***

Please see *Bucket Repairs* in this section.

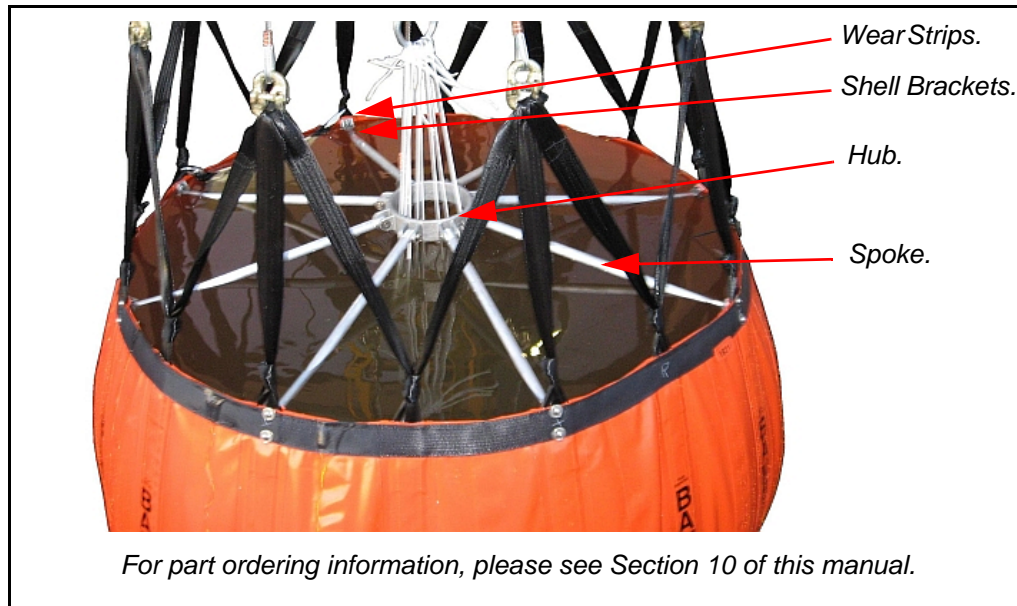
**IDS Hub/Spokes Replacement**

The IDS can be purchased either as a complete kit or as individual pieces, as required. Follow the procedure below to replace the entire assembly.

1. Start by removing the old IDS including the shell brackets and the old restrainer cable brackets. You will have to disconnect the tripline from the valve or control head since the tripline passes through the hub.
2. For re-assembly, first install the new shell brackets. This can be accomplished by installing the bolts through the bucket shell, fitting the fabric wear strips onto the bolts and, then, fitting the brackets to the bolts. Install and tighten the Nylock nuts.
3. Install the two restrainer cable brackets. One is found below the ballast and the other is directly opposite (6 o'clock position). No wear strips are required for the restrainer cable brackets.
4. With the ballast oriented at the 6 o'clock position, rotate the IDS assembly so that the deployment cable faces upward and it's at the 3 o'clock position.
5. Attach the two spokes at either side of the 12 o'clock position using the stainless steel clevis pins. Complete by fitting the fender washer and cotter pin. Working around the bucket perimeter, attach the rest of the spokes.
6. Once the IDS is fully installed, test for fit. You should be able to pull the hub past the midpoint position with a slight effort. If the IDS is either too loose or too tight, it will require adjustment.
7. Remember to re-attach the tripline to the dump valve, passing the line through the hub. Also, attach the IDS deployment cable to the control head small adjustment chain.
8. Attach the two restrainer cables.

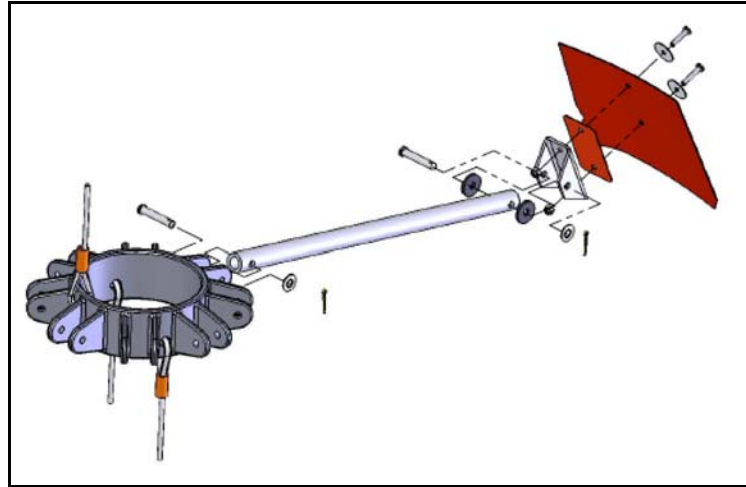

If the IDS is too tight, adjust two of the spokes as follows:

1. Cut off the spoke just above the existing hole on one end only. Then, redrill a new hole centred the same distance from the new end of the spoke as the other spokes. This will likely produce a good fit.
2. If the IDS is still too tight remove another spoke and repeat the above steps.
3. These two spokes are across from each other.

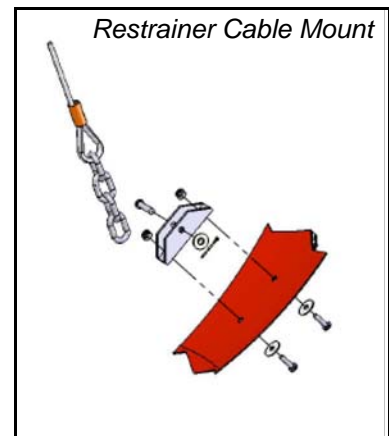

## Bambi Bucket Shell Repairs

Please read these instructions carefully and follow them exactly to obtain a good repair. Failure to follow these instructions or poor repair workmanship can lead to failed repairs and/or more damage to the bucket.

Before commencing repairs using glue, the weather should be warm (above 60 deg. F or 15 deg. C) and dry.

### Important Note

Try a test repair before attempting to repair the bucket. This will verify your technique without risking damage to the bucket. It is much harder to fix a repair once a failed attempt has been made as the hardened glue is difficult to remove.

### Repair Failures

Repairs will likely fail if:

- The area to be repaired is not perfectly clean and scrubbed to a matte finish before applying the patch.
- Repairs are attempted during wet or cold weather.
- The glue and patch are not properly placed, creating air bubbles between the glue and the patch.
- The patch is not weighed down for 24 hours.
- The bucket is used before the glue has set.

### Important Note

Dura-Seal glue has been designed specifically for the SEI family of fabrics. The shelf life of this adhesive is about one year. Fresh adhesive can be obtained directly from SEI Industries Ltd.



***Repairing in High Humidity***

In conditions of high humidity, a proper technique is essential for securing the bond strength desired. The presence of surface moisture can destroy the effectiveness of the cemented bond.

The evaporation of solvent from the adhesive may reduce surface temperature below the dew point resulting in condensation of water vapour on the surface of the adhesive. This is often visible as fogging or a milky white appearance on the surface.

The use of a solvent to clean the surface prior to cementing can also reduce temperatures below the dew point.

To overcome the high humidity problem, raise the temperature of the patch area. This can be accomplished with a warm air fan.

**Warning**

- Glue vapours are highly explosive! Explosive vapours may occur causing fire and/or injury. Keep away from all sparks, flame, lighters or cigarettes.
- Solvent and glue are both extremely hazardous. Use solvent and glue under well ventilated conditions only.
- Use an approved respirator mask to avoid breathing fumes.
- When using a warm air fan, either use one which is rated EXPLOSION PROOF or make sure that there is a steady flow of air past the work area to remove fumes as they are generated.

### ***Making Temporary Repairs with Sealing Clamps***

Repair clamps are used for an immediate repair to prevent the loss of liquid through large rips or holes. For example, if a vehicle accidentally backed into a bucket and caused a 3" (76 mm) long rip in the bucket, a repair clamp could be inserted to stop the loss of liquid. Repair clamps are only used for temporary repairs. The damage should be permanently repaired with a patch when the bucket can be emptied.

#### **Important Note**

Leaving the clamp's string on makes it easier to remove the repair clamp when placing a permanent patch on the bucket.

1. Select the largest clamp that will just slip through the hole in the item. The size of cut or hole will determine the size of the sealing clamp to use.
  - For a cut or hole up to 2" (5 cm), use a 3" (7.6 cm) clamp.
  - For a cut or hole up to 4" (10 cm), use a 5" (12.7 cm) clamp.
  - For a cut or hole up to 6" (15 cm), use a 7.5" (19 cm) clamp.

#### **Caution**

Use caution if deciding to enlarge the slit to insert a clamp. It is very easy to make the slit too large.

2. Keeping hold of the string, slip one half of the repair clamp through the hole as indicated.



3. Pull the bolt up through the hole. Turn it until the clamp lines up with the hole.



4. Place the top of the clamp over the bolt.



5. Tighten the nut by hand.



**Caution**

Tightening the nut with tools may break the bolt away from the lower clamp. Overtightening can also deform the clamp and cause leaks.

## Temporary Repairs Using Glue

### Important Note

Allow repair to harden for 24 hours at room temperature before using the item.

### Applying the Glue

Small scrapes, damaged fabric coating or pinholes, which are not leaking, can be repaired with glue only. They do not require a patch. (A small scrape is defined as damage to the outer fabric coating only. A pinhole is defined as a small puncture that is not leaking.) However, damage to the base fabric must be repaired with a patch.

1. Fill the weight bag with water prior to beginning repairs.
2. Clean the area to be repaired with an abrasive pad dampened with solvent. Remove all traces of masking tape, if previously used. If possible, place a piece of masking tape on the back side of the item being repaired.

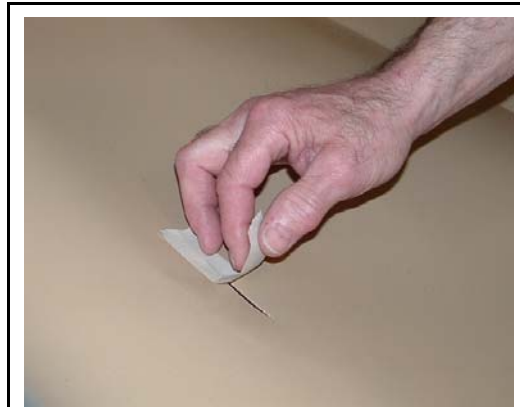

*Apply masking tape on the backside of the tear.*

3. Paint the damaged area with glue. Use a thick coat of glue, overlapping the edges of the repair by 1" (25 mm). Be sure that the edges are well coated. A damaged coating should be given two coats of glue. Apply the second coat within four hours of the first coat.



*Squeeze glue around tear and spread with fingers.*

### Gluing with Patches

If liquid is escaping or there is dampness around the damaged area, the item must be drained. If the damaged area is still dry, it will be possible to obtain a good bond without draining the item. Any loose coating should be cut back with scissors. Trim to a point where there is a solid bond between the reinforcing fabric or scrim and the coating.

1. Support the damaged area on a flat, solid platform. If the item is drained, the damaged area should be supported above the rest of the item. This allows residual liquid to drain away from the damaged area. This platform should be strong enough to support the fabric (flat) and allow the patch to be rolled once it is in place.



*The damaged area should be supported on a flat, solid platform.*

2. Scrub the damaged area with an abrasive pad dampened with solvent (isopropyl rubbing alcohol is recommended). Scrub vigorously to remove the cured surface. The area should be clean and dry with a dull matte finish.



#### Caution

Solvent will damage the fabric if too much is used or if the fabric is left exposed to solvent residue.

3. Wipe with a rag, dampened with solvent, to remove any residue from cleaning. Check to see if the area is totally clean and all coated surfaces and edges are dull. If not, repeat the cleaning. This is critical for a good glue bond.

### Cutting the Patch

1. Cut a patch. The patch should be at least 2" (50 mm) larger in every direction from the damaged area. A round patch is recommended but, if a rectangular patch covers the damage better, then round all corners.



*The color of patch will vary, depending on the product repair kit.*

2. Clean the patch by scrubbing with a pad dampened with solvent. Rub vigorously to remove the gloss from the fabric. Clean **both sides of the patch**, as it is easy to get the patch turned over during installation. Another reason the patch should be cleaned on both sides is that it will be painted with glue, on the outside, later.



### Applying the Patch

1. Apply the Dura-Seal glue to the patch and damaged area. Wait 30 minutes (at 75F or 22C) for some of the solvent to evaporate from the glue. The glue should become thicker but still be quite wet. If it has been allowed to dry too long, give both sides another thin coat. If the glue has dried too long, it will be difficult to avoid entrapping air bubbles in the bonded joint.

2. Place the patch and roll it down with the roller. Place the centre of the patch down first, then roll it out towards the edges with the roller. This expels trapped air. Once the patch is rolled down, do not let it lift up. This will prevent air from getting under the patch which causes a weak bond.



3. If the item is sloped during the repair, tape the patch in place, while holding it down. This stops the patch from sliding away from the damaged area.

4. Weigh down the patch. Place a plastic cover sheet over the patch followed by a weight bag for 12 hours at room temperature. The item can then be moved but should not be filled until the glue has cured for 24 hours. The weight bag should hold the patch tight against the item while the glue sets. The plastic cover sheet will prevent the glue from sticking to the weight bag.



5. If the patch will be subjected to abrasion after 24 hours, paint over the patch with glue. Painting the patch also provides protection from ultra violet light and weather. Allow the bond to harden for 24 hours at room temperature before using the item.

### ***Using Other Glues***

If you do not have any Dura-Seal available, there are two other glues that can be used and are typically easy to purchase locally.

1. Loctite 495 can be used to provide a quick patch repair but it will make a long term repair difficult at a later date as all Loctite 495 glue must be removed before applying Dura-Seal. This can prove to be a time-consuming, stubborn task.

**Warning**

Loctite 495 carries the following warning: Irritating by inhalation. Eye irritant. Combustible liquid. Contains cyanoacrilate ester which may cause allergic skin reactions. Skin contact through clothing may cause burns. Use adequate ventilation in case of eye or body contact. Flush with water. Get medical attention for eye or internal contact.

2. The other glue option is 3M's 420 glue which has the advantage of creating a more permanent repair. If using this glue, follow the same instructions in this manual as for Dura-Seal adhesive.



## Hot Air Gun Patching

On most items, hot air gun patching is the preferred method because it provides the most durable, permanent repair possible.

Tools and materials required:

- Patches
- One plastic hand-held roller
- One hot air gun, Steinel HL 1800 E or equivalent: 120 V-1500 W (800 to 1100 deg. F, 450 litres per min.)
- One wide surface nozzle
- Isopropyl alcohol
- Scissors

### Warning

It is extremely dangerous to use a hot air gun in the presence of flammable fumes such as gasoline or paint thinner. There is a high risk of explosion and/or burns.

### Warning

Injury, especially to hands and fingers, can occur when using a hot air gun. Most welding will occur at temperatures of 800-1000 degrees F. Wear gloves to protect skin from overheating, burning and blistering.

**Hot Air Gun Procedure**

1. In a well-ventilated location, clean the area to be repaired as well as one side of the patch with an abrasive pad. Wipe down the repair area and patch with isopropyl alcohol.
2. Mount a wide surface air nozzle on the hot air gun so as to direct the heat flow in a large pattern. Turn the power on, adjust the temperature in the low range first and let the hot air gun warm up. Increase the temperature as required during the operation. **DO NOT OVERHEAT OR BLACKEN THE FABRIC.**

**Caution**

Overheating can occur quickly and can damage the product.

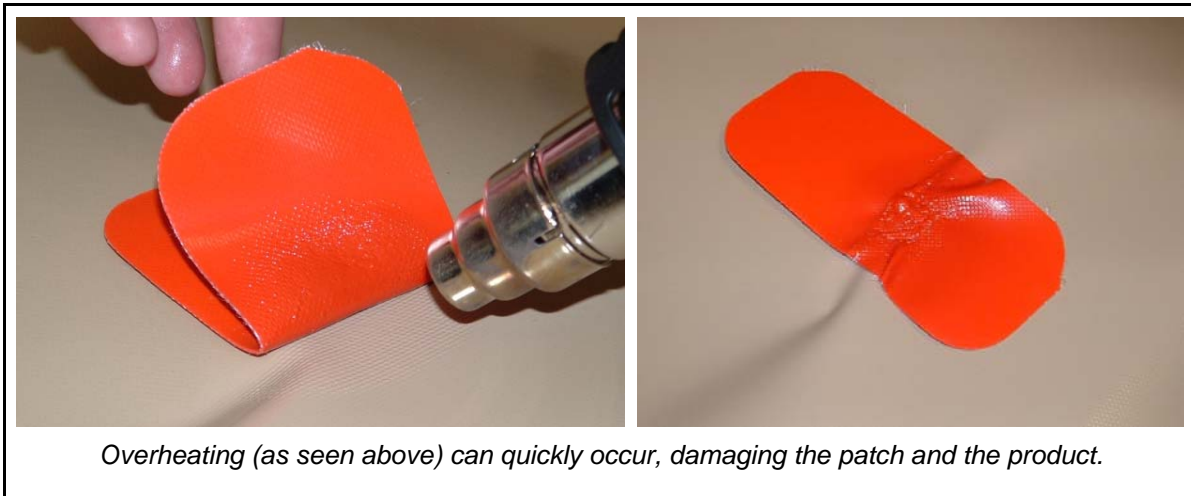

*Overheating (as seen above) can quickly occur, damaging the patch and the product.*

3. Starting from the centre of the patch (held down by the roller), concentrate the heat flow equally to patch and fabric. Apply a light pressure with the roller when the fabric starts melting. This can be seen as small bubbles. **DO NOT OVERHEAT.**



4. Roll the patch down to fuse it to the fabric, moving roller and gun simultaneously. Repeat on the unfused portion of the patch. Let the repaired area cool down. Attempt to peel off at the edges with your fingers. If there is even a slight peel, repeat the operation locally. Otherwise, the repair is finished.

## Repair Kits

### **Bambi Repair Kit REPKM001**

(used for Bambi buckets or other product lines as per customer request)

### **Bambi Repair Kit REPKM001NG (no glue)**

(used for Bambi buckets or other product lines where **no glue is required or allowed.**)

#### **Important Note**

It is the responsibility of the dealer and end user to ensure that the importation of glue is allowed in the country of use.



PART NUMBER	DESCRIPTION	QTY.
REPM100	FABRIC REPAIR MANUAL	1
REPP001B	POUCH FOR BAMBI REPAIR KIT	1
REPB001	WEIGHT BAG	1
PP504	ABBRASIVE PAD	2
PK030	ZIPLOCK BAG	2
PP510	ROLLER PLASTIC 1 ¼"	1
PP513	SCISSORS	1
TT105	CLAMP SMALL	1
PP525	ADHESIVE, DURA-SEAL 1oz. (see note above)	2
REPP100	PATCHES FOR ALL BAMBI'S AFTER 2001	3

## Section 9: Specifications and Parts

### Capacity and Weight Specifications

Bambi Model	Capacity			Gross Weight		Empty Weight	
	IMP Gal	USG Gal	Liters	lb	kg	lb	kg
2024	200	240	910	2100	970	135	61
2024S	200	240	910	2100	970	130	59
2226	220	260	1000	2300	1100	130	59
2732	270	320	1200	2800	1300	140	64
2732S	270	320	1200	2800	1300	135	61
3542	350	420	1600	3700	1700	150	68
4453	440	530	2000	4600	2100	180	82

**Note:** Capacities and weights are accurate to within 5%. Specifications subject to change. Check original control head nameplate.

#### Caution

The selection of a Bambi bucket model for a specific aircraft is dependent on many factors including aircraft weight, fuel weight, operation elevation and atmospheric conditions.

The helicopter operator must select a bucket model which is appropriate for their specific situation.

The operator must also ensure that the bucket selected does not pose a tail rotor strike hazard.

**Control Head Parts List, Models 2024-4453, Major Components**

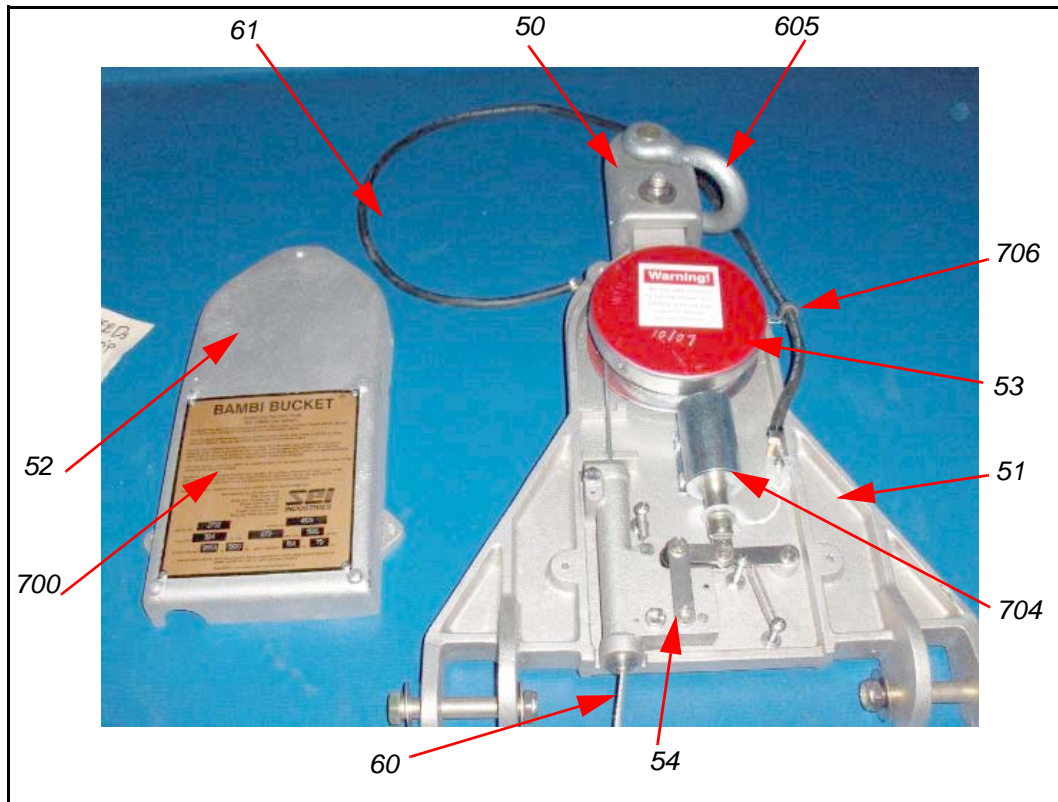

ITEM	MODEL	PART #	DESCRIPTION	QTY
50	ALL	BB068	YOKE	1
51	ALL	BB051	HEAD CASTING	1
52	ALL	BB060	HEAD COVER	1
53	ALL	BB019A	SPRING REEL	1
54	ALL	BB064	TRIP BLOCK	1
60	ALL	BB386	TRIP LINE ASSY	1
61	ALL	BB067	LEAD WIRE	1
605	ALL	FTAG003	SHACKLE, ANCHOR, GALV, 3/4	1
700	ALL	LB001E	SPECIFICATION PLATE, ENGRAVED	1
704	ALL	BB001AL	SOLENOID w/HARDWARE	1
706	ALL	PP013	CABLE CLAMP, RUBBER LINED, 3/8	1

**Control Head Parts List, Models 2024-4453, Bolts, Nuts and Washers**

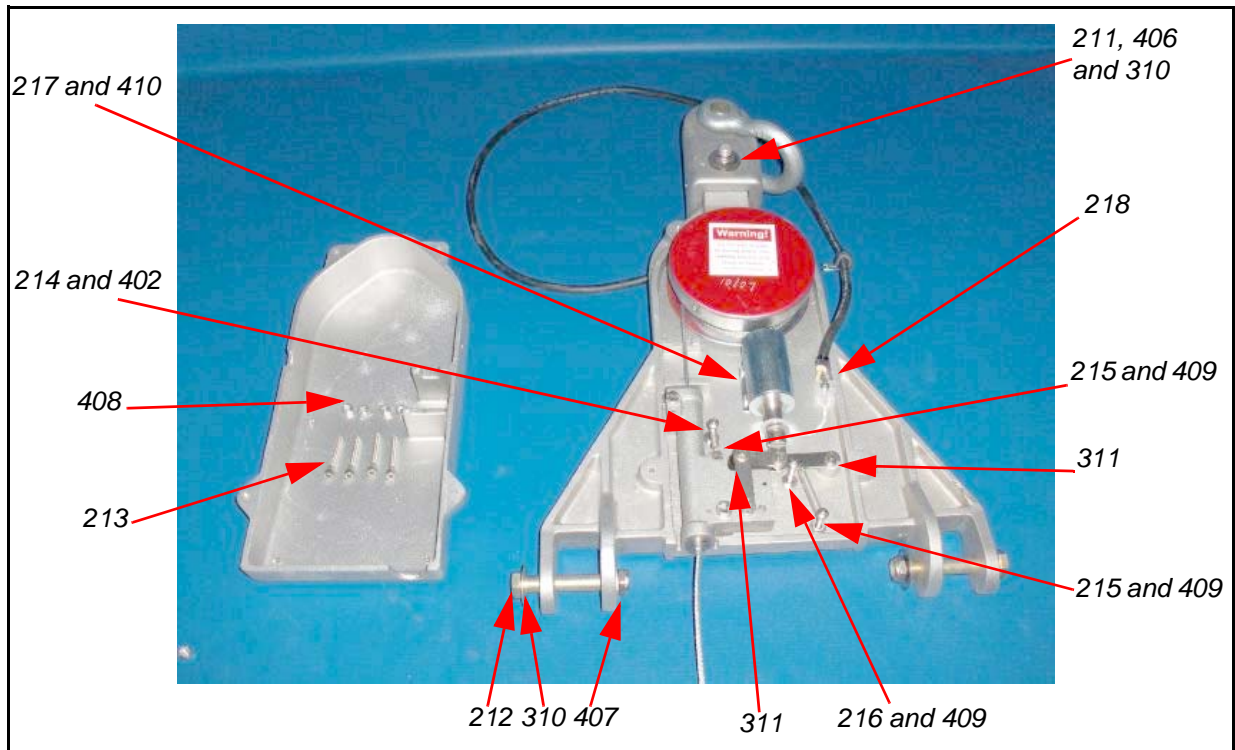

ITEM	MODEL	PART #	DESCRIPTION	QTY
211	ALL	FBCC021026	BOLT, SHOULDER, SOCHD, 5/8 X 2-3/4 X 1/2-13	1
212	ALL	FBCF010830	BOLT, HEX HEAD, PLATED, 1/2-20 X 3	2
213	ALL	FBSF070314	CAPSCREW, SOC HD, SS, 10-32 X 1-1/2	4
214	ALL	FBSC010420	BOLT, HEX HEAD, SS, 1/4-20 X 2	2
215	ALL	FBSC040312	MACHINE SCREW, PAN PHIL, SS, 10-24 X 1-1/4	2
216	ALL	FBSC040314	MACHINE SCREW, PAN PHIL, SS, 10-24 X 1-1/2	1
217	ALL	FBSC070105	CAPSCREW, SOC HD, SS, 6-32 X 5/8	4
218	ALL	FSS060206	SCREW, PANPHIL, #8 X 3/4	1
310	ALL	FWS0208	WASHER, FLAT, SS, 1/2 X 1-1/4	5
311	ALL	FWS0304	WASHER, FLAT, SS, 1/4 X 1/2	15
406	ALL	FNCS0308	NUT, NYLOCK JAM, SS, 1/2-13	1
407	ALL	FNSF02082	NUT, NYLOCK JAM, SS, 1/2-20	2
408	ALL	FNSF0203	NUT, NYLOCK, SS, 10-32	4
402	ALL	FNCS0204	NUT, NYLOCK, SS, 1/4-20	2
409	ALL	FNCS0103	NUT, HEX, SS, 10-24	3
410	ALL	FNCS0201	NUT, NYLOCK, SS, 6-32	4

**Control Head Parts List, Models 2024-4453, Catch, Linkage and Terminal Block**

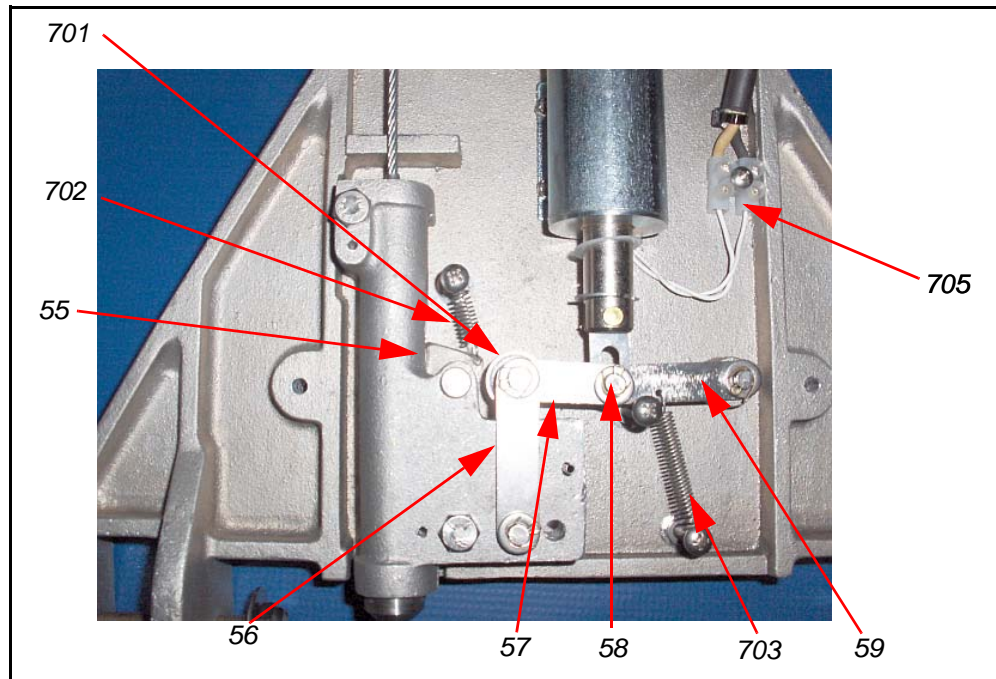

ITEM	MODEL	PART NUMBER	DESCRIPTION	QTY
55	ALL	BB012	CATCH	1
56	ALL	BB003	LONG LNK	2
57	ALL	BB004	SHORT LINK	2
58	ALL	BB005	SLOTTED LINK	1
59	ALL	BB006	SPRING LINK	1
701	ALL	PPB002	BEARING	1
702	ALL	BB021	CATCH SPRING	1
703	ALL	BB022	RETURN SPRING	1
705	All	PP010	TERMINAL BLOCK	1



**Control Head Parts List, Models 2024-4453, Clevis, Cotter and Split Pins**

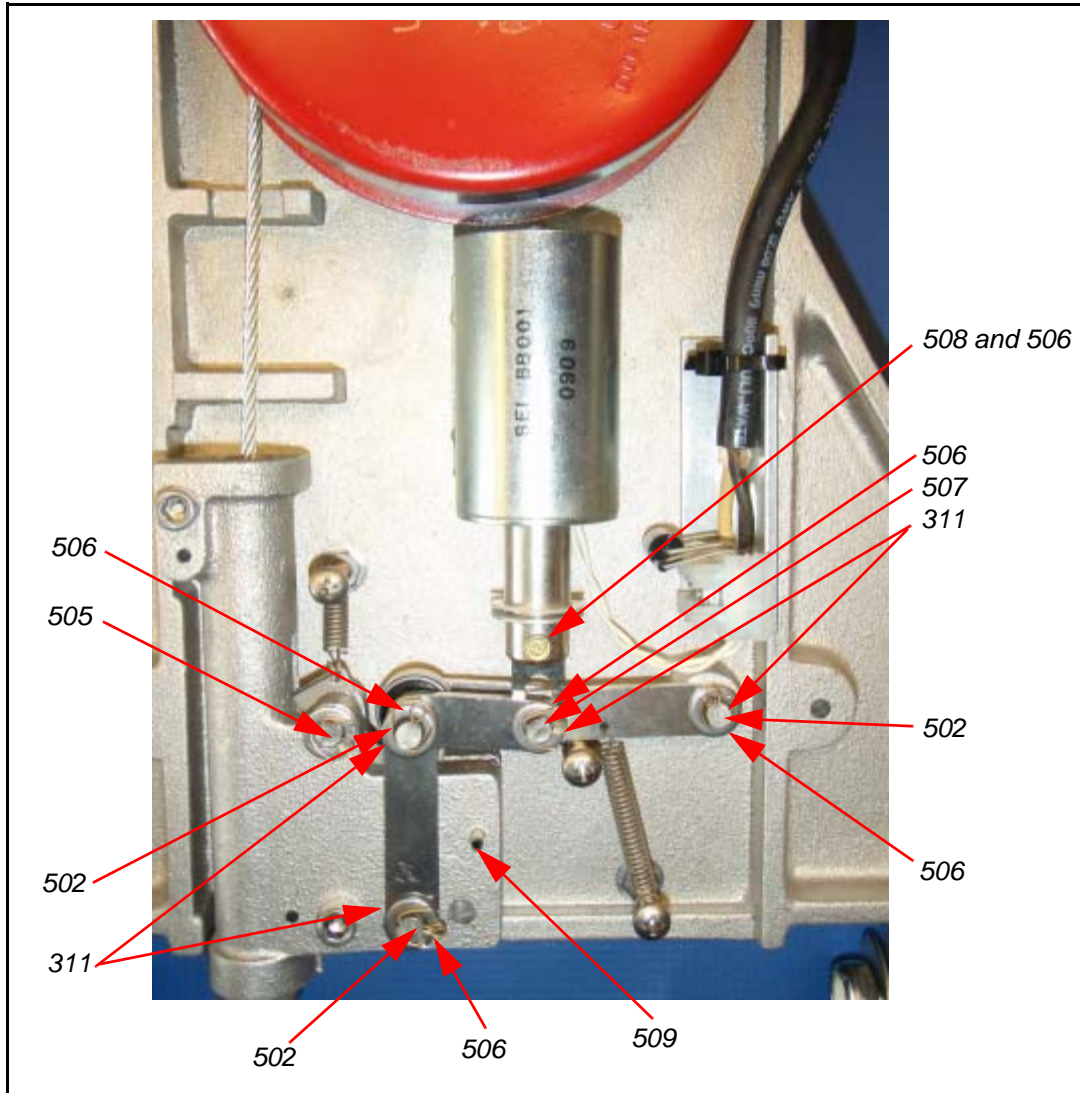

ITEM	MODEL	PART #	DESCRIPTION	QTY
311	ALL	FWS0304	WASHER, FLAT, SS, 1/4 X 1/2	15
502	ALL	FPCS005	CLEVIS PIN, SS, 1/4 X 1-1/4	3
505	ALL	FPCS003	CLEVIS PIN, SS, 1/4 X 1	1
506	ALL	FPDC001	COTTER PIN, PLATED, 1/16 X 1	6
507	ALL	FPCS002	CLEVIS PIN, SS, 1/4 X 3/4	1
508	ALL	FPCS001	CLEVIS PIN, SS, 1/8 X 21/32	1
509	ALL	FPSS003	SPLIT PIN, SS, 1/8 X 1-1/4	1

Valve Models 2024-3542

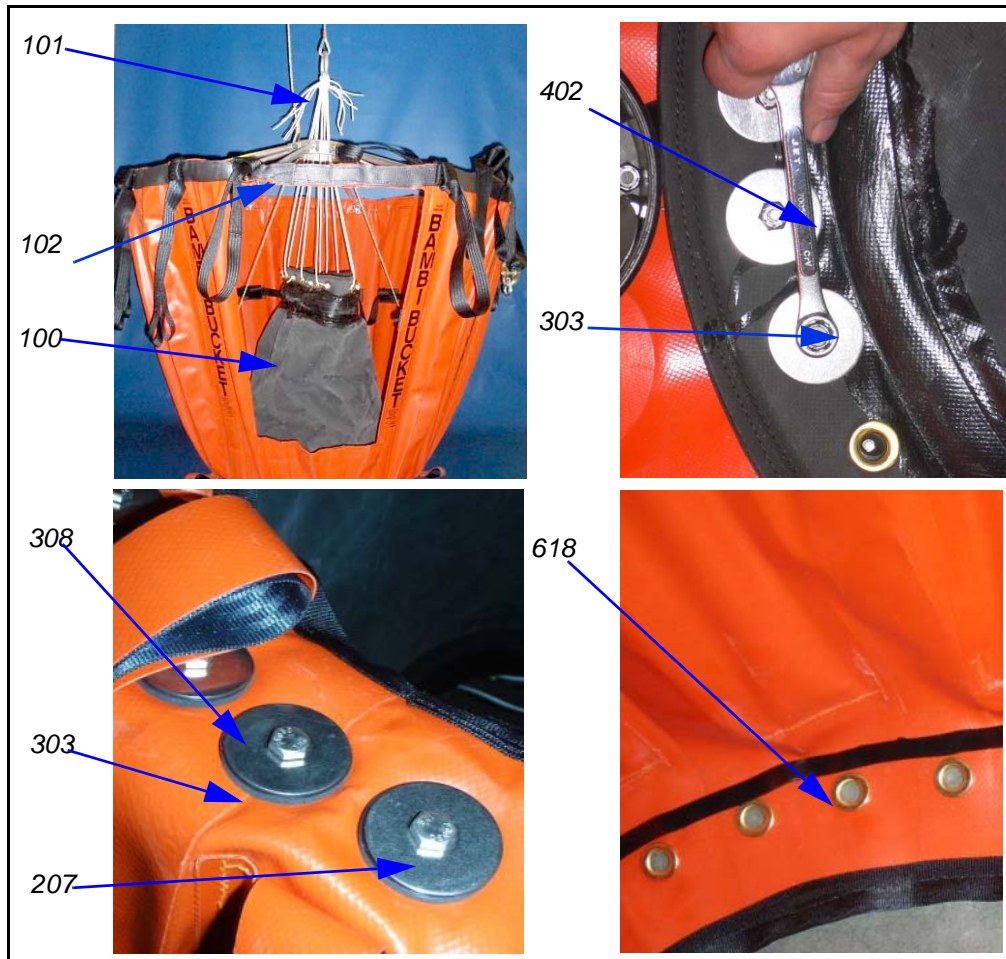

ITEM	MODEL	PART #	DESCRIPTION	QTY
100	ALL	BB252	DUMP VALVE Models 2024-3542	1
101	ALL	BB770	PURSE STRING Models 2024-3542	14
102	2024	BB280S	RING, RISER & RESTRAINER CABLES	1
	2024S	BB280SHS		
	2226	BB280S		
	2226S	BB280SHS		
	2732	BB281S		
	2732S	BB281SHS		
	3542	BB282S		
207	ALL	FBSC010410	BOLT, HEX HEAD, SS, 1/4-20 X 1	35
303	ALL	FWS0604	WASHER, FLAT, SS, 1/4 X 1-1/2	70
308	ALL	FWR0107	WASHER, FLAT, RUBBER, 1/4 X 1-1/2	35
402	ALL	FNCS0204	NUT, NYLOCK , SS, 1/4-20	35
618	ALL	PP020	BUTYL TAPE	

Valve Model 4453

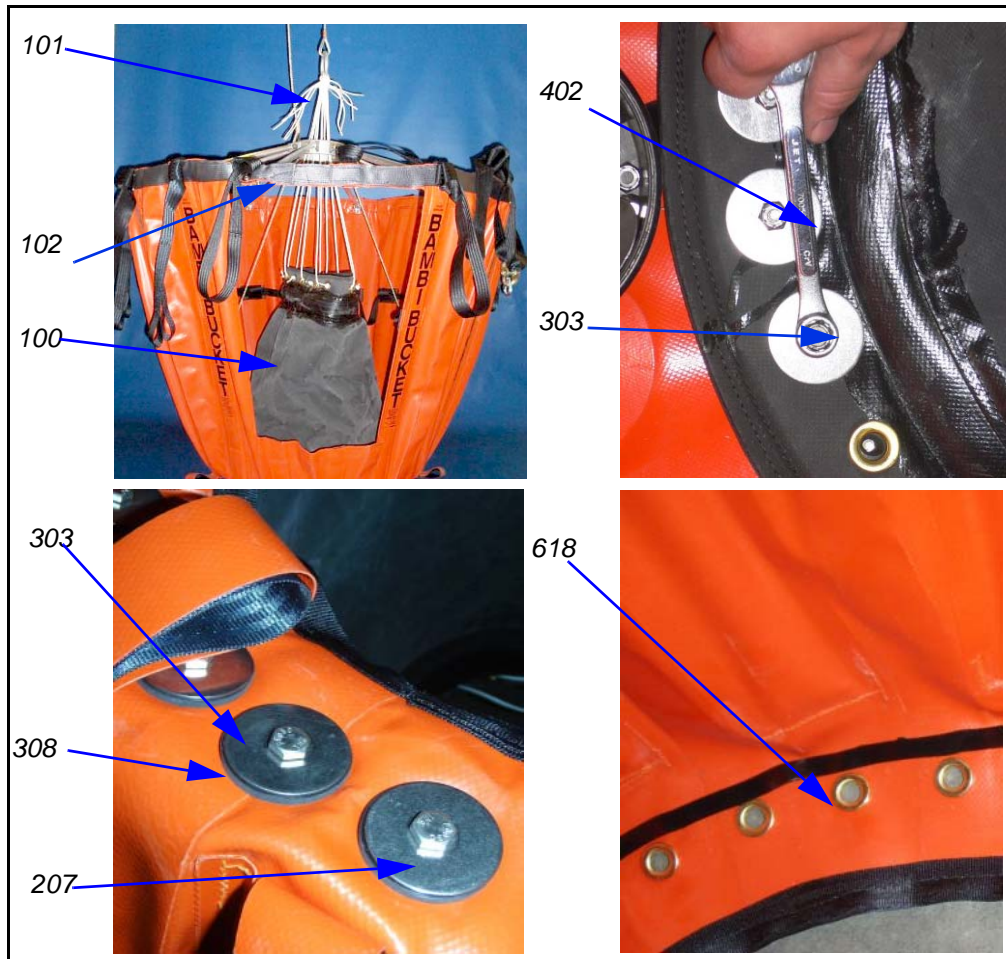

ITEM	MODEL	PART #	DESCRIPTION	QTY
100	4453	BB253	DUMP VALVE	1
101	4453	BB771	PURSE STRING	17
102	4453	BB2821S	RING, RISER & RESTRAINER CABLES	1
207	4453	FBSC010410	BOLT, HEX HEAD, SS, 1/4-20 X 1	40
303	4453	FWS0604	WASHER, FLAT, SS, 1/4 X 1-1/2	80
308	4453	FWR0107	WASHER, FLAT, RUBBER, 1/4 X 1-1/2	40
402	4453	FNCS0204	NUT, NYLOCK , SS, 1/4-20	40
618	ALL	PP020	BUTYL TAPE	10'

**Valve Kits**

Valve kits include valve, purse strings, bolts, nuts, washers and butyl tape.

PART #	DESCRIPTION	QTY
BB252A	VALVE KIT 2024-3542	1
BB253A	VALVE KIT 4453-HL9800	1

**Bucket Shell, Models 2024-4453**

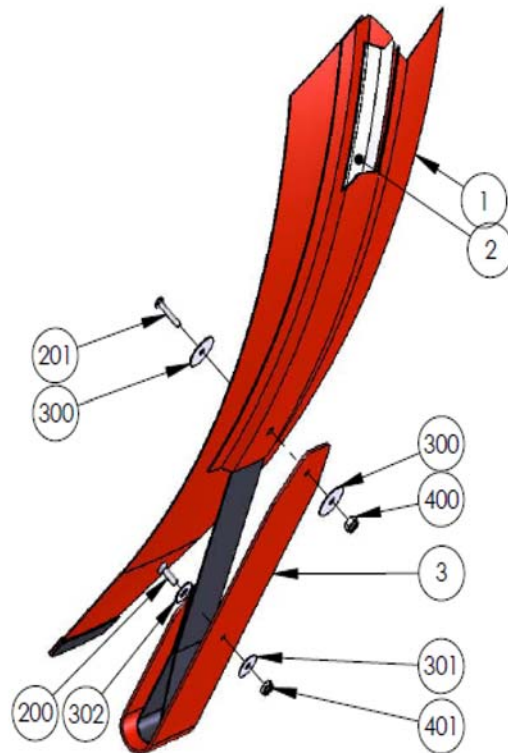
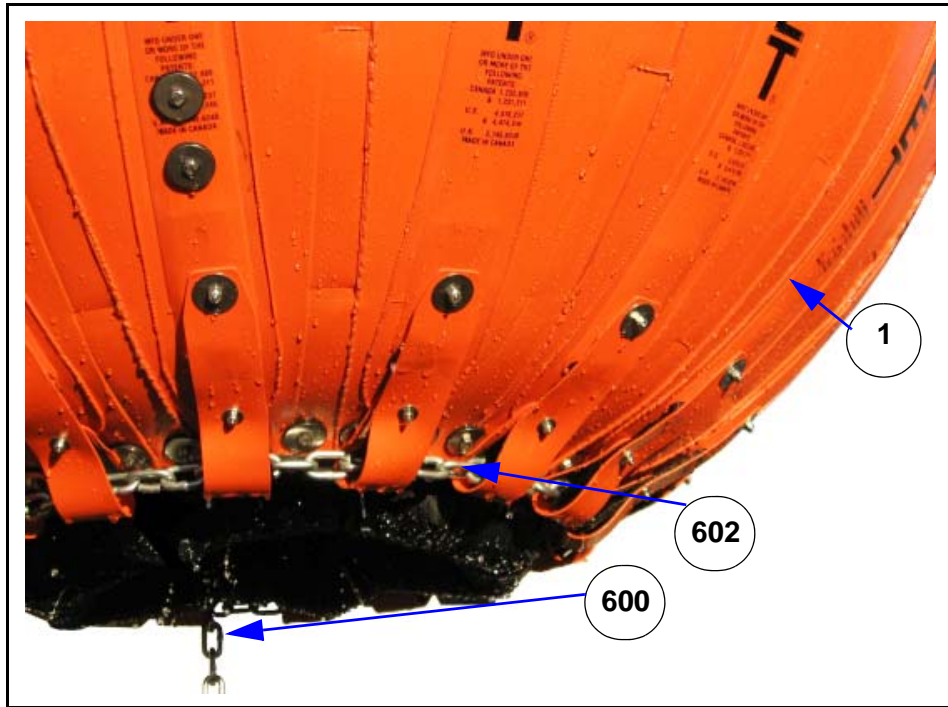

**Bucket Shell, Models 2024-4453 (continued)**

ITEM	MODEL	PART #	DESCRIPTION	QTY
1	2024	BB960	SHELL	1
	2024S			
	2226	BB959		
	2226S			
	2732	BB961		
	2732S			
	3542	BB962		
4453	BB963			
2	2024	BB610	BATTEN, 36-1/2"	16
	2024S			
	2226			
	2226S			
	2732	BB611	BATTEN, 38-1/2"	
	2732S			
	3542	BB612	BATTEN, 48-1/2"	
4453	BB613	BATTEN, 47-1/2"		
3	ALL	BB08200BU	WEAR STRIP, LOWER, Models 2024-5566	16
200	ALL	FBSC030305	MACHINE SCREW, FLATPHIL, SS, 10-24 X 5/8	16
201	ALL	FBSC040307	MACHINE SCREW, PAN PHIL, SS, 10-24 X 7/8	14
300	ALL	FWS060310	WASHER, FLAT, SS, 3/16 X 1	28
301	ALL	FWS060306	WASHER, FLAT, SS, 3/16 X 3/4	16
302	ALL	FWS01040	WASHER, FLAT, SS, 1/4 X 11/16	16
400	ALL	FNCS0203	NUT, NYLOCK, SS, 10-24	14
401	ALL	FNCS02032	NUT, NYLOCK JAM, SS, 10-24	16
600	ALL	FTAG001	SHACKLE, ANCHOR, GALV, 1/4	1
602	2024	RMCG003	CHAIN, GALV, GR30, 5/16	65"
	2024S			
	2226			
	2226S			
	2732			
	2732S			
	320C			
	3542			
	4453			
				72"
				80"

**Cinch Strap, Models 2024-4453**

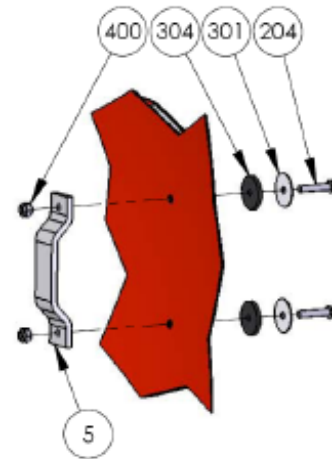

ITEM	MODEL	PART #	DESCRIPTION	QTY
4	2024	BB710	CINCH STRAP, 144"	1
	2024S			
	2226			
	2226S			
	2732	BB711		
	2732S			
	3542			
4453	BB712	CINCH STRAP, 188"		
5	ALL	BB749	CINCH STRAP BRACKET	16
204	ALL	FBSC040310	MACHINE SCREW, PAN PHIL, SS, 10-24 X 1	32
301	ALL	FWS060310	WASHER, FLAT, SS, 3/16 X 1	32
304	ALL	FWR0103	WASHER, FLAT, RUBBER, 3/16 X 1	32
400	ALL	FNSC0203	NUT, NYLOCK, SS, 10-24	32

Page left intentionally blank.



*Rigging, Models 2024-4453*

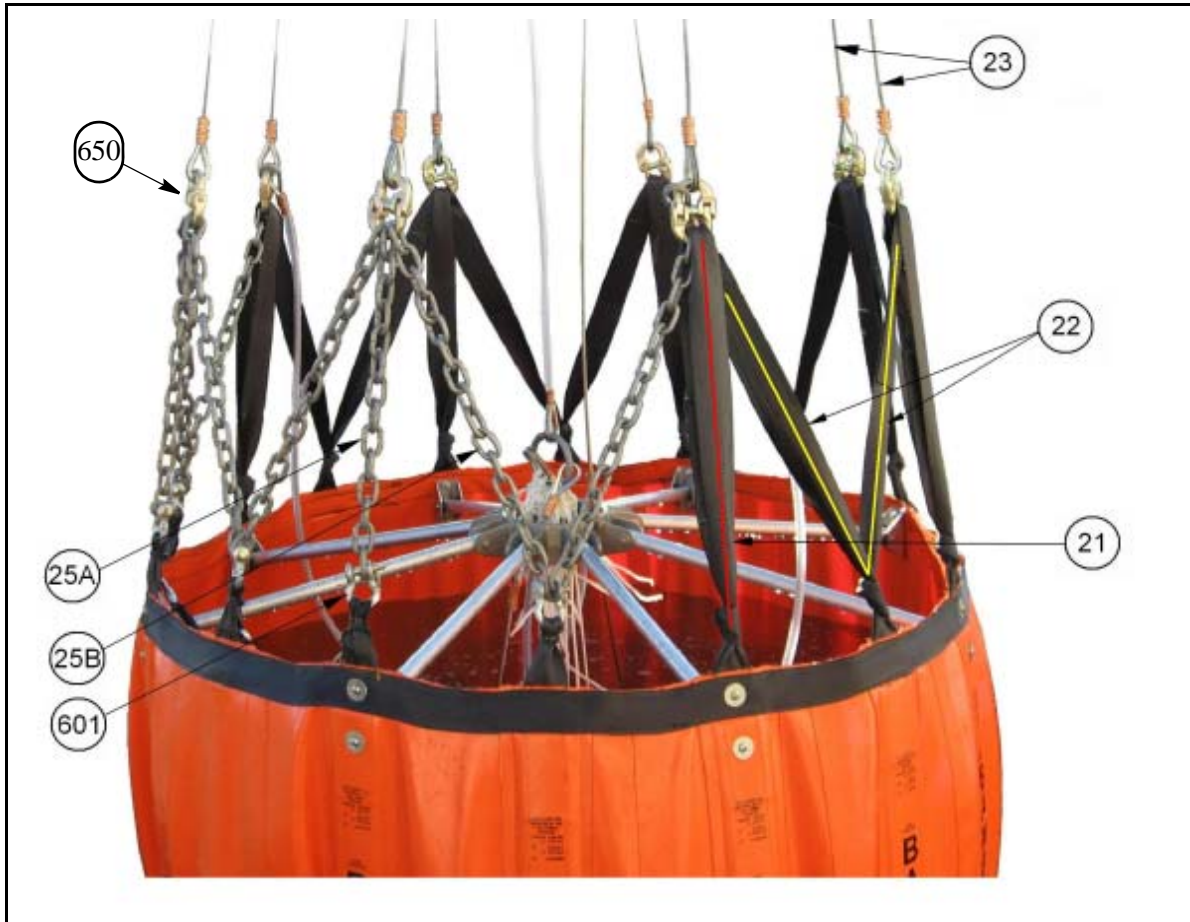

**Rigging, Models 2024-4453 (continued)**

ITEM	MODEL	PART #	DESCRIPTION	QTY
21	2024	BB674	M-STRAP, LOOP, 18-3/8"	6
	2024S			
	2226			
	2226S			
	2732	BB677		
	2732S			
	3542			
	4453			
22	2024	BB675	M-STRAP, STRAIGHT, 40-3/4"	5
	2024S			
	2226			
	2226S			
	2732	BB678		
	2732S			
	3542			
	4453			
23	2024	BB805	SUSPENSION LINE, PAIR	4
	2024S	BB805S		
	2226	BB805		
	2226S	BB805S		
	2732	BB806		
	2732S	BB806S		
	3542	BB806		
	4453			
25A	2024	BB780	CHAIN, TOP, 14-1/2"	2
	2024S			
	2226			
	2226S			
	2732	BB782		
	2732S			
	3542			
	4453			
25B	2024	BB781	CHAIN, TOP, 16-1/2"	6
	2024S			
	2226			
	2226S			
	2732	BB783		
	2732S			
	3542			
	4453			
601	ALL	FTAG002	SHACKLE, ANCHOR, GALV, 5/16	5
605	ALL	FTL0016	CONNECTING LINK	8

*IDS System, Models 2024-4453*

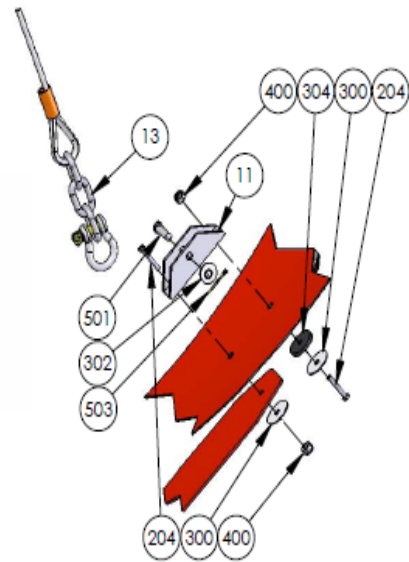
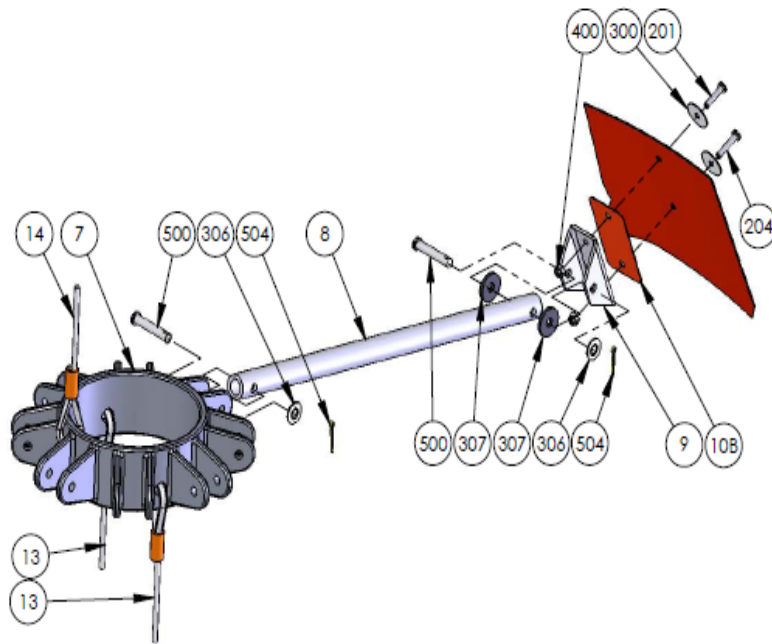

*IDS System, Models 2024-4453 (continued)*

ITEM	MODEL	PART #	DESCRIPTION	QTY
7	ALL	BB456	HUB	1
	2024	BB4561A	HUB w/ deployment and restrainer cables	1
	2266	BB4561A		
	2732	BB4562A		
	3542	BB4563A		
	4453	BB4564A		
8	2024	BB410	SPOKE, TUBE, 16-7/8"	8
	2024S			
	2226	BB4105	SPOKE, TUBE, 19-1/2"	
	2226S			
	2732	BB411	SPOKE, TUBE, 20-1/8"	
	2732S			
	3542	BB412	SPOKE, TUBE, 21-3/4"	
4453	BB413	SPOKE, TUBE, 24-3/4"		
9	ALL	BB465	SHELL BRACKET	8
10B	ALL	BB468	WEAR STRIP, MEDIUM	8
11	ALL	BB330	RESTRAINER BRACKET	2
13	2024	BB310	RESTRAINER CABLE ASSY	2
	2024S			
	2226			
	2226S			
	2732	BB311		
	2732S			
	3542			
4453	BB313			
14	2024	BB360	IDS Deployment Cable	1
	2024S	BB360-S		
	2226	BB360		
	2226S	BB360-S		
	2732	BB361		
	2732S	BB361S		
	320C	BB361		
	3542			
	4453			

*IDS System, Models 2024-4453 (continued)*

201	ALL	FBSC040307	MACHINE SCREW, PAN PHIL, SS, 10-24 X 7/8	8
204	ALL	FBSC040310	MACHINE SCREW, PAN PHIL, SS, 10-24 X 1	12
300	ALL	FWS060310	WASHER, FLAT, SS, 3/16 X 1	20
302	ALL	FWS01040	WASHER, FLAT, SS, 1/4 X 11/16	2
304	ALL	FWR0103	WASHER, FLAT, RUBBER, 3/16 X 1	2
306	ALL	FWS060506	WASHER, FLAT, SS, 5/16 X 3/4	16
307	ALL	FWR0105	WASHER, FLAT, RUBBER, 5/16 X 1	16
400	ALL	FNSC0203	NUT, NYLOCK, SS, 10-24	20
500	ALL	FPCC020	CLEVIS PIN, PLATED, 5/16 X 1-3/4	16
501	ALL	FPCS004	CLEVIS PIN, SS, 1/4 X 1-1/8	2
503	ALL	FPDB001	COTTER PIN, PLATED, 1/16 X 3/4	2
504	ALL	FPDC002	COTTER PIN, PLATED, 3/32 X 3/4	16

**Ballast Systems, Models 2024-3542**

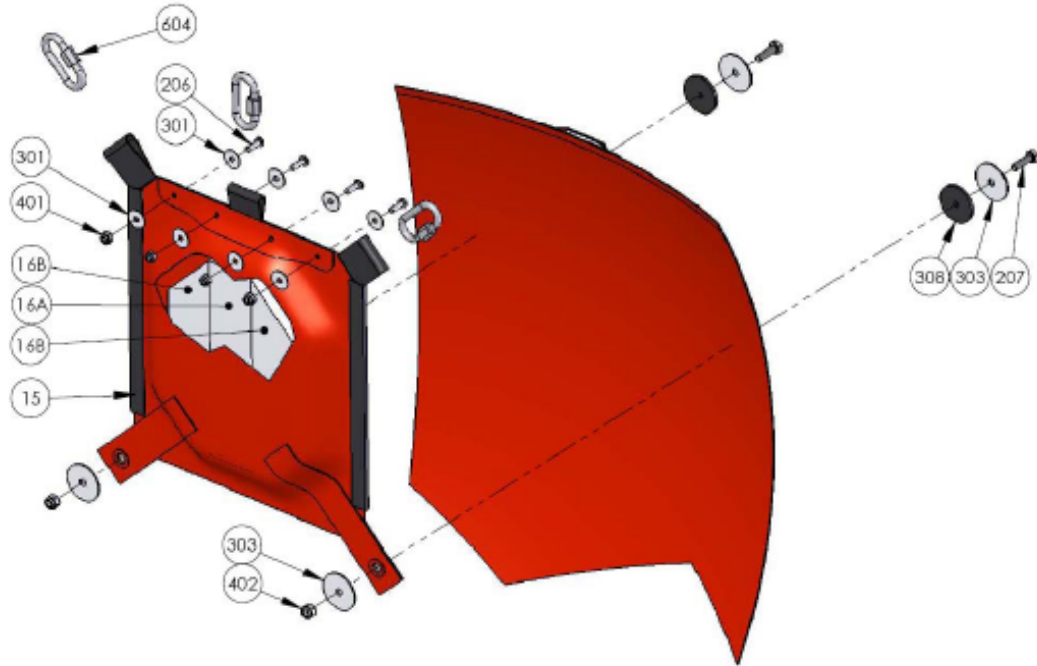

ITEM	MODEL	PART #	DESCRIPTION	QTY
15	2024	BB64682	BALLAST POUCH	1
	2024S			
	2226	BB64683		
	2226S			
	2732			
	2732S			
3542	BB64684			
16A	ALL	BB661	BALLAST BAR, SQUARE, GALV, 10 LB	1
16B	ALL	BB662	BALLAST BAR, TAPER, GALV, 10 LB	2
604	ALL	PP203	QUICK LINK, 1/4	3
207	ALL	FBSC010410	BOLT, HEX HEAD, SS, 1/4-20 X 1	2
303	ALL	FWS0604	WASHER, FLAT, SS, 1/4 X 1-1/2	4
308	ALL	FWR0107	WASHER, FLAT, RUBBER, 1/4 X 1-1/2	2
402	ALL	FNSC0204	NUT, NYLOCK , SS, 1/4-20	2
206	ALL	FBSC040304	MACHINE SCREW, PAN PHIL, SS, 10-24 X 1/2	4
301	ALL	FWS060306	WASHER, FLAT, SS, 3/16 X 3/4	8
400	ALL	FNSC0203	NUT, NYLOCK, SS, 10-24	4

**Ballast Systems, Model 4453**

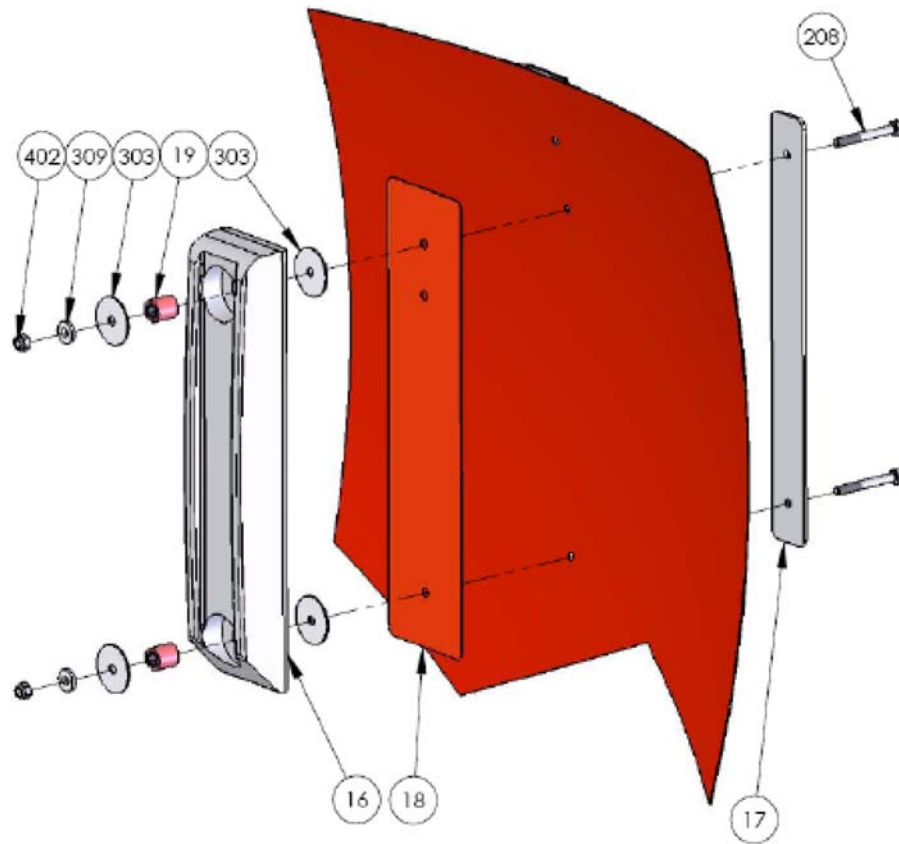

ITEM	MODEL	PART #	DESCRIPTION	QTY
16	4453	BB655A	BALLAST BAR, GALV STEEL, 16 LB	3
17	4453	BB655B	BACKING PLATE, BALLAST BAR	3
18	4453	BB659	WEAR STRIP, BALLAST BAR	3
19	4453		SPACER, BALLAST BAR	6
208	4453	FBSC010422	BOLT, HEX HEAD, SS, 1/4-20 X 2-1/4	6
309	4453	FWS0104H	WASHER, FLAT, SS, 1/4 X 3/4 X 1/8	6
303	4453	FWS0604	WASHER, FLAT, SS, 1/4 X 1-1/2	12
402	4453	FNSC0204	NUT, NYLOCK , SS, 1/4-20	6

**Packaging Parts List**

Part No.	Description	Qty.
BB-860	Bag, Carrying, 2024-4453	1
REPP100	Fabric Patches	1
TT-105	Small clamp	
TT-106	Medium clamp	
TT-107	Large clamp	
PP-510	Roller	
Special order	Hot Air Gun	
Special order	Glue - specify model/fabric type	
REPKM001	Comes Complete with all materials required for patching.	1
REPKM001NG	Complete kit with no glue due to shipping restrictions. Refer to <i>Section 9, Bucket Maintenance</i> for more information.	1

## Trouble Shooter Kit Model 2024-3542 (BBK003)

Part No.	Description	Qty.
BB001A	Solenoid and piston 28 volts, c/w bolts	1
BB019A	Spring reel, heavy duty, assembled	1
BB252	Valve dump 2024-3542	1
BB885	Purse string set 2024-3542	1
FBSC010410	Bolt, hex head S/S ¼-20 X 1"	35
FNSC0204	Nut, Nylock, S/S ¼-20	35
FWR0107	Washer, 1/8" neoprene, 7/32" x 1 ½"	35
FWS0604	Washer, fender, S/S ¼" x 1 ½"	70
PP020	Butyl tape, black, 1/6" x 3/8"	10
BB386	Tripline, BB 2024-4453	1

## Trouble Shooter Kit Model 4453 (BBK 006)

Part No.	Description	Qty.
BB001A	Solenoid and piston 28 volts C/W bolts	1
BB019A	Spring reel, heavy duty, assembled	1
BB253	Valve dump 4453	1
BB890	Purse string set 4453	1
FBSC010410	Bolt, hex head S/S ¼-20 X 1"	40
FNSC0204	Nut, Nylock, S/S ¼-20	40
FWR0107	Washer, 1/8" neoprene, 7/32" x 1 ½"	40
FWS0604	Washer, fender, S/S ¼" x 1 ½"	80
PP020	Butyl tape, black, 1/6" x 3/8"	10
BB386	Tripline, 4453	1



# Section 10: Warranty

SEI Industries Ltd. (the Company) agrees to grant a warranty for a period of one year from the date of purchase of Bambi bucket systems on the following conditions:

- a) The company's sole obligation under this warranty is limited to repairing or replacing, at the company's sole discretion, any product shown to be defective.
- b) The company's products are not guaranteed for any specific length of time or measure of service, but are warranted only to be free from defects in workmanship and material for a period of one year to the original purchaser.
- c) To the extent allowable under applicable law, the company's liability for consequential and incidental damages is expressly disclaimed. **The company's liability in all events is limited to and shall not exceed, the purchase price paid.**
- d) This warranty is granted to the original purchaser of Bambi bucket systems and does not extend to a subsequent purchaser or assignee.
- e) The company must receive notification in writing of any claims of warranty from the original purchaser which must give details of the claimed defect in the product.
- f) Where the original purchaser is claiming under warranty, the product must be returned to the company for inspection with all transportation and duty charges prepaid.
- g) The warranty does not extend to any product that has been accidentally damaged, abraded, altered, punctured, abused, misused or used for a purpose which has not been approved by the company.
- h) This warranty does not apply to any accessories used with the product that are not supplied by the company and any warranty on such accessories must be requested from the manufacturer or dealer of the accessories.
- i) In the event the original purchaser does not give notice of a warranty claim, within one year of the original purchase of the product, it is understood that the purchaser has waived the claim for warranty and the purchaser and/or any subsequent purchaser must accept the condition of the product, without warranty.
- j) Any technical information supplied by the company regarding the product is not a condition of warranty but rather is information provided by the company to the best of its knowledge.
- k) There are no implied warranties nor is there any warranty that can be assumed from any representation of any person, except the company itself.

### Exclusions

- l) This warranty is void if the product is not installed, used and/or maintained in accordance with the operations manual supplied by SEI.
- m) All Bambi buckets are designed and manufactured with substantial safety margins. It is the responsibility of the user to ensure that the bucket is maintained to a safe standard.

# Section 11: Drawings

## Pilot Controls

ITEM	DESCRIPTION	SPECIFICATION
CB1	CIRCUIT BREAKER, 1A	MS22073-1
CB2	CIRCUIT BREAKER, 10A	MS22073-10
K1	RELAY, DPDT, 10A	AW3314
S1	SWITCH, SPST, MOMENTARY	MS24523-28
J1	CONNECTOR, RECEPTACLE	MS3101E-24-11S
P1	CONNECTOR, PLUG	MS3107B-24-11P
J2,J3	CONNECTOR, RECEPTACLE	NEMA 5-15R
P2,P3	CONNECTOR, PLUG	NEMA 5-15P
---	WIRE, #20 AWG	MS22759/16-20
---	WIRE, #14 AWG	MS22759/16-14

LENGTH	GAUGE	TYPE
50 FT	#14 AWG	14/2 SOW
75 FT	#14 AWG	14/2 SOW
100 FT	#14 AWG	14/2 SOW
125 FT	#12 AWG	12/2 SOW
150 FT	#12 AWG	12/2 SOW
200 FT	#12 AWG	12/2 SOW

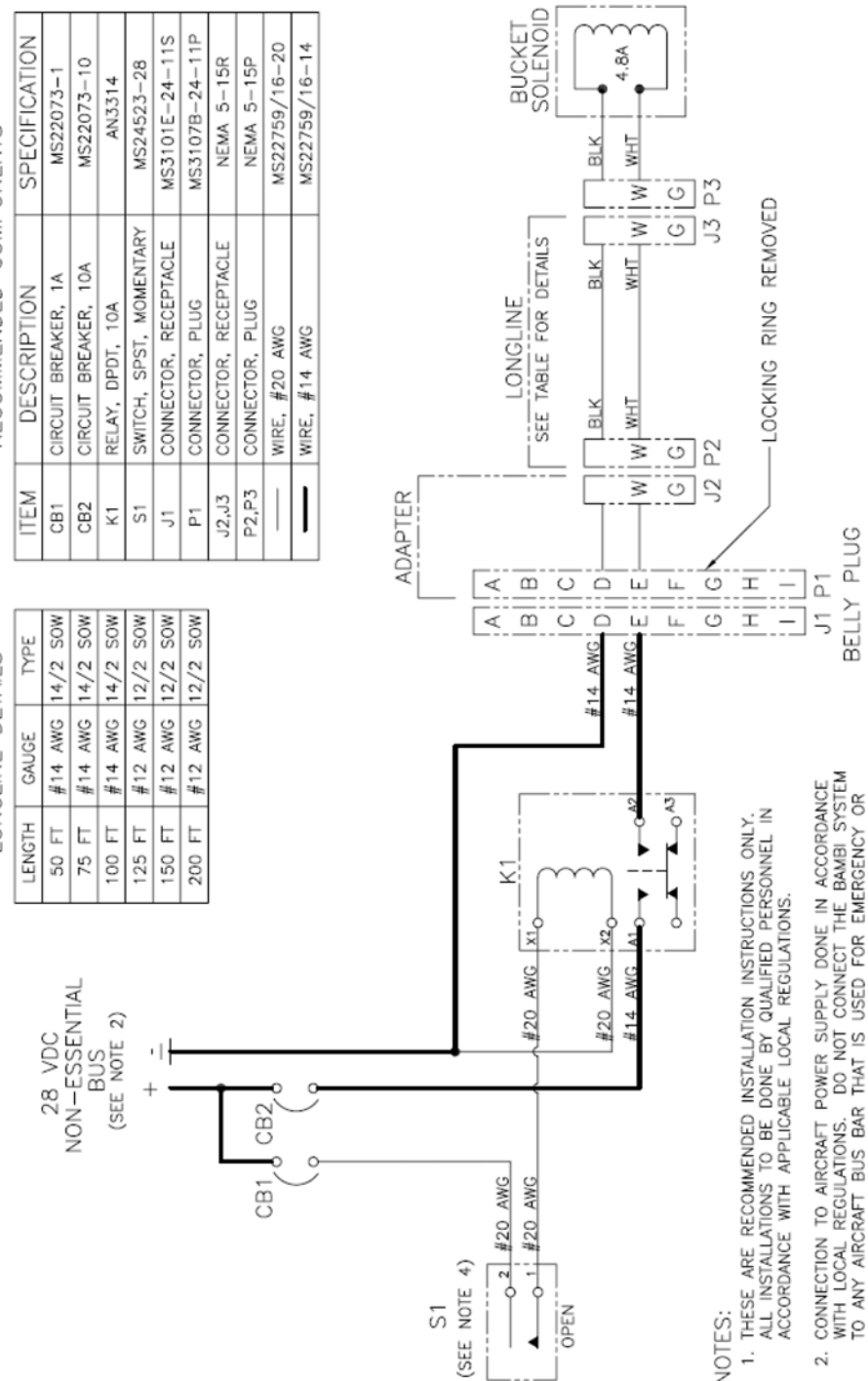

- NOTES:
1. THESE ARE RECOMMENDED INSTALLATION INSTRUCTIONS ONLY. ALL INSTALLATIONS TO BE DONE BY QUALIFIED PERSONNEL IN ACCORDANCE WITH APPLICABLE LOCAL REGULATIONS.
  2. CONNECTION TO AIRCRAFT POWER SUPPLY DONE IN ACCORDANCE WITH LOCAL REGULATIONS. DO NOT CONNECT THE BAMB1 SYSTEM TO ANY AIRCRAFT BUS BAR THAT IS USED FOR EMERGENCY OR ESSENTIAL LOADS. AMMEND THE AIRCRAFT ELECTRICAL LOAD ANALYSIS TO ENSURE THAT THE GENERATOR CAPACITY IS ADEQUATE TO OPERATE THE SYSTEM.
  3. ALL GROUNDS, SOLDERED TERMINALS, AND CRIMPED TERMINALS DONE IN ACCORDANCE WITH AIRCRAFT MANUFACTURERS INSTRUCTIONS.
  4. CONSULT LOCAL CONTRACT REGULATIONS FOR LOCATION OF THE ACTUATION SWITCH.

## PILOT CONTROLS

Pilot Controls, US InterAgency

RECOMMENDED COMPONENTS

ITEM	DESCRIPTION	SPECIFICATION
CB1	CIRCUIT BREAKER, 1A	MS22073-1
CB2	CIRCUIT BREAKER, 50A	MS24571-50
K1	RELAY, SPST, 50A	MS24166-D1
S1	SWITCH, SPST, MOMENTARY	MS24523-28
J1	CONNECTOR, RECEPTACLE	MS3101E-24-11S
P1	CONNECTOR, PLUG	MS3107B-24-11P
J2,J3	CONNECTOR, RECEPTACLE	NEMA 5-15R
P2,P3	CONNECTOR, PLUG	NEMA 5-15P
—	WIRE, #20 AWG	MS22759/16-20
—	WIRE, #8 AWG	MS22759/16-8

LONGLINE DETAILS

LENGTH	GAUGE	TYPE
50 FT	#14 AWG	14/2 SOW
75 FT	#14 AWG	14/2 SOW
100 FT	#14 AWG	14/2 SOW
125 FT	#12 AWG	12/2 SOW
150 FT	#12 AWG	12/2 SOW
200 FT	#12 AWG	12/2 SOW

28 VDC  
NON-ESSENTIAL  
BUS  
(SEE NOTE 2)

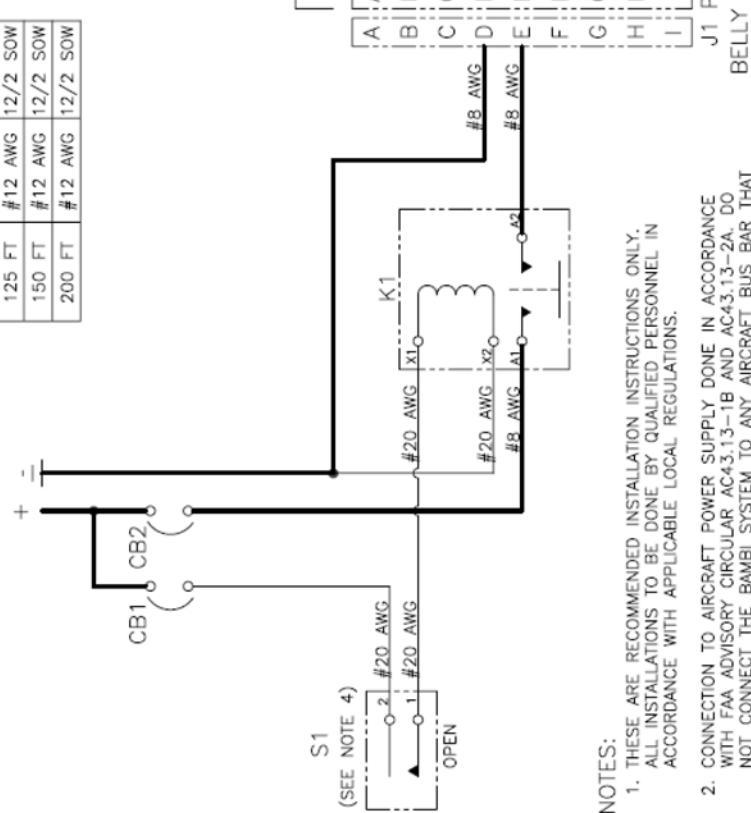

NOTES:

1. THESE ARE RECOMMENDED INSTALLATION INSTRUCTIONS ONLY. ALL INSTALLATIONS TO BE DONE BY QUALIFIED PERSONNEL IN ACCORDANCE WITH APPLICABLE LOCAL REGULATIONS.
2. CONNECTION TO AIRCRAFT POWER SUPPLY DONE IN ACCORDANCE WITH FAA ADVISORY CIRCULAR AC43.13-1B AND AC43.13-2A. DO NOT CONNECT THE BAMBİ SYSTEM TO ANY AIRCRAFT BUS BAR THAT IS USED FOR EMERGENCY OR ESSENTIAL LOADS. AMMEND THE AIRCRAFT ELECTRICAL LOAD ANALYSIS TO ENSURE THAT THE GENERATOR CAPACITY IS ADEQUATE TO OPERATE THE SYSTEM.
3. ALL GROUNDS, SOLDERED TERMINALS, AND CRIMPED TERMINALS DONE IN ACCORDANCE WITH AIRCRAFT MANUFACTURERS INSTRUCTIONS.
4. ACTUATION SWITCH MOUNTED ON THE COLLECTIVE PITCH LEVER. SWITCH MARKED "OPEN" AND SPRING-LOADED TO THE OFF POSITION.

PILOT CONTROLS  
US INTERAGENCY

**Bambi Crew Controls**

RECOMMENDED COMPONENTS

ITEM	DESCRIPTION	SPECIFICATION
CB1	CIRCUIT BREAKER, 10A	MS22073-10
S1	SWITCH, SPST, MOMENTARY	MS16712-1
J1,J2	CONNECTOR, RECEPTACLE	NEMA 5-15R
P1,P2	CONNECTOR, PLUG	NEMA 5-15P
---	WIRE, #14 AWG	MS22759/16-14

LONGLINE DETAILS

LENGTH	GAUGE	TYPE
50 FT	#14 AWG	14/2 SOW
75 FT	#14 AWG	14/2 SOW
100 FT	#14 AWG	14/2 SOW
125 FT	#12 AWG	12/2 SOW
150 FT	#12 AWG	12/2 SOW
200 FT	#12 AWG	12/2 SOW

28 VDC  
NON-ESSENTIAL  
BUS  
(SEE NOTE 2)

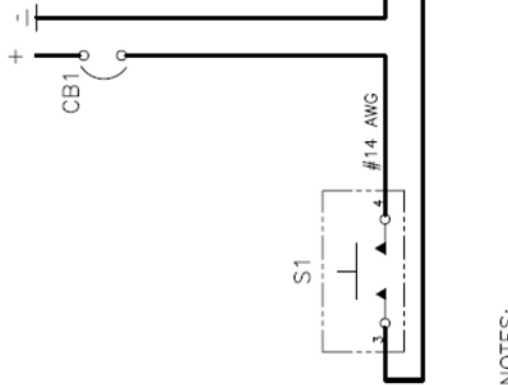

NOTES:

1. THESE ARE RECOMMENDED INSTALLATION INSTRUCTIONS ONLY. ALL INSTALLATIONS TO BE DONE BY QUALIFIED PERSONNEL IN ACCORDANCE WITH APPLICABLE LOCAL REGULATIONS.
2. CONNECTION TO AIRCRAFT POWER SUPPLY DONE IN ACCORDANCE WITH FAA ADVISORY CIRCULAR AC43.13-1B AND AC43.13-2A. DO NOT CONNECT THE BAMBİ SYSTEM TO ANY AIRCRAFT BUS BAR THAT IS USED FOR EMERGENCY OR ESSENTIAL LOADS. AMEND THE AIRCRAFT ELECTRICAL LOAD ANALYSIS TO ENSURE THAT THE GENERATOR CAPACITY IS ADEQUATE TO OPERATE THE SYSTEM.
3. ALL GROUNDS, SOLDERED TERMINALS, AND CRIMPED TERMINALS DONE IN ACCORDANCE WITH AIRCRAFT MANUFACTURERS INSTRUCTIONS.

CREW CONTROLS

**Bambi Crew Controls (using remote power supply)**

